



vLoc3-5000 User Handbook (English Edition)

Version 1.8

P/N:4.04.000106



General Safety & Care Information

Who Can Use This Equipment

- This equipment must only be used by people suitably trained in the use of pipe and cable locators.

Work-site Safety

- Use your company's or other applicable safety codes and rules when using this equipment.
- Unless having the required authorization, license, and appropriate training, do not connect any pipe, cable, or conductor.
- The equipment should not come in contact with corrosive or hazardous chemicals or gases, or dust.
- **Do not** directly connect this equipment to cables or pipes that have a potential difference to the ground of greater than 25V AC.

Equipment Safety

- **Do not** open the enclosures (housings) of either the transmitter or receiver.
- Place the ground stake firmly in the ground before connecting the cable from the transmitter.
- **Do not** hold any uninsulated portion of the connection leads & clips when the transmitter is switched on.

Batteries and Environmental Safety

Vivax-Metrotech products use four types of batteries:

- Alkaline batteries
- Ni-MH (Nickel-Metal Hydride) batteries – rechargeable
- Lithium-Ion batteries – rechargeable
- Lithium-Metal batteries – (small non-rechargeable button cells for "clock" applications)

1. Alkaline Batteries (Non-Rechargeable)

- When replacing the alkaline batteries – use only the size and type specified – **do not** mix battery types (rechargeable and alkaline).
- **Do not** mix partially discharged and fully charged cells in the same battery pack – **do not** mix old with new.
- **Never** attempt to charge alkaline batteries.

2. Nickel-Metal Hydride Batteries (Rechargeable)

- When using rechargeable batteries, use only the correct charging device supplied or specified by the manufacturer. The battery pack or the battery charger will contain circuitry to manage the charging process – other chargers (even if they have the same connector, polarity, voltage & current rating will not have the same control circuitry and can cause damage to the product, overheating, and in extreme cases fire or harm to the individual.
- **Do not** assume that if the plug fits, it is the correct charger – a charger with the correct part number **must** be used – just because it is a Vivax-Metrotech charger and the plug fits **does not** mean it is the correct charger.
- Before using for the first time, charge rechargeable batteries for six hours. If the rechargeable batteries **do not** last as long as anticipated – discharge fully and then charge for six hours.
- Care should be taken when charging batteries – **Never** repeatedly recharge batteries (or turn the power off & on) without using the instrument. If used with an inverter in a vehicle – charge the product, then unplug the charger and **do not** charge again until the rechargeable batteries have been used for at least ten minutes. Failure to do this could result in the overcharging of the battery, which will shorten the battery's life and could, in some circumstances, cause overheating or fire.
- If the product becomes hot during the charging process, **immediately** unplug the charger and use the rechargeable batteries for at least ten minutes before recharging. If this reoccurs the next time, the unit is charged – return immediately to Vivax-Metrotech for repair.
- **Do not** charge batteries for prolonged periods without using the locator for at least ten minutes. Charging for a prolonged period could overcharge the battery, reduce battery life and in extreme circumstances cause damage to the locator and fire in extreme circumstances.

3. Lithium-Ion Batteries (Rechargeable)

- Lithium-Ion Batteries – some products use Lithium-Ion batteries – the requirements for marking and transportation are still developing. Please contact Vivax-Metrotech before shipping products containing Lithium-Ion batteries or Lithium-Ion battery packs on their own for any "special instructions."

4. Lithium-Metal Batteries (Non-Rechargeable)

- Commonly known as "button cells," these are small – non-rechargeable batteries used to power internal "clocks" within some units (similar to computers). Generally, they have a life of three to five years.
- Under no circumstances should any attempt be made to charge these batteries.
- Dispose of to your company's work practice/environmental standards, the prevailing laws, or recognized best practices. Always dispose of batteries responsibly.

5. General Rules regarding Disposal of Batteries

- **Never** disassemble a battery or battery pack.
- **Never** dispose of in a fire or water.
- Dispose of batteries following your company's work practice/environmental standards, the prevailing laws, or recognized best practices. Always dispose of batteries responsibly.

6. Transportation of Lithium-Ion and Lithium-Metal Batteries

- The Lithium-Ion and Lithium-Metal batteries used in Vivax-Metrotech products meet the required safety standards and include the designated protection circuitry.
- Recent regulation changes require that when batteries with Lithium-Ion and Lithium-Metal batteries are transported, the packaging **must** include specified warning labels.
- **Please contact Vivax-Metrotech Customer Service (USA 1-800-446-3392, International +1-408-734-3880 (USA Pacific Time Zone)) for more details.**
- Regulations have also changed regarding the shipping of spare battery packs (battery packs that are not inside a product). There are limitations on the weight of the package, and the packaging must be marked with the appropriate warning labels.
- **Please contact Vivax-Metrotech Customer Service (USA 1-800-446-3392, International +1-408-734-3880 (USA Pacific Time Zone)) for more details.**
- Vivax-Metrotech vLoc Series 3 products using Lithium-Ion batteries are classified as "not restricted." They can be shipped normally by road/rail/sea & air (passenger & freight aircraft) without restrictions.



IMPORTANT

Remember – Batteries contain dangerous chemicals – They can be affected by many things such as water ingress or heat – In some circumstances, they can explode. They also can cause electric shocks!

Care of Equipment

- Use equipment only as directed in this User Handbook.
- **Do not** immerse any part of this equipment in the water.
- Store in a dry place.
- Keep equipment in the case provided when not in use.
- If left for a prolonged period – remove alkaline batteries.
- Keep the unit clean and free of dust and dirt.
- Protect against excessive heat.

Care when Interpreting the Information provided by the Locator

- This instrument locates and provides depth and current readings based on electromagnetic signals radiating from the buried cable or pipe. In most cases, these signals will enable the locator to pinpoint both position depth and current correctly.
- **Beware** – in some cases, other factors will distort electromagnetic fields radiating from the cable or pipe being located, resulting in incorrect information.
- Always locate responsibly and use information learned during your training to interpret the information provided by the locator.
- **Do not** provide information regarding the depth of cable or pipe to anyone unless authorized by your company.
- **Remember** that depth measurements are to the center of the electromagnetic field or pipe – In the case of pipes this may be significantly deeper than the top.

American & Canadian Safety Notices

USA

- This transmitter and receiver comply with the general conditions of operation, according to part 15 of the FCC Rules.
 - o CFR 47 Part 2
 - o CFR 47 Part 15
- Changes or modifications not expressly approved by the manufacturer could void the user's authority to operate the products.





CANADA





- Equipment is for use by trained operators only and not for general household or consumer use.
- Operation is subject to the following two conditions: (1) this device may not cause interference, and (2) this device must accept any interference that may cause undesired operation of the device.

EUROPE

- Vivax-Metrotech confirms that the location system is compliant with the relevant provision of European directive 1999/5/EC.
 - o EN 55011
 - o EN 61000-4-2: A1 & A2
 - o EN 61000-4-3
 - o EN 61000-4-8: A1
 - o ETSI EN 300 330-2
 - o ETSI EN 301 489-1
 - o ETSI EN 301 489-3

Table of Content

1. Service & Support	1
1.1 Serial Number and Software Revision Number	1
1.2 Worldwide Sales Offices and Service Centers	2
2. vLoc3-5000 Receiver	3
2.1 vLoc3-5000 Receiver Overview	3
2.2 Charging the Receiver Batteries	4
2.3 vLoc3-5000 Receiver Keypad	5
2.4 The vLoc3-5000 User Menu	5
2.4.1 Setup - Receiver	5
2.4.2 Setup - Operational	6
2.4.3 Setup - Features	7
2.4.4 Setup - Informational	7
2.4.5 Self-Test	7
2.5 Warnings and Alerts	8
2.5.1 Warnings and Alerts Descriptions	8
2.5.2 DFT (Discrete Fourier Transform)	8
2.5.3 vLoc3 Series Locate Modes and Screens	10
2.5.4 The Classic Screen Status Bar	10
2.5.5 The Classic Screen	11
2.6 Classic Locating Modes (Response)	12
2.6.1 Peak Response Mode 	12
2.6.2 Broad-Peak Mode 	12
2.6.3 Null Mode 	12
2.6.4 Delta Null 	13
2.6.5 Omni-Peak Response Mode 	13
2.7 Information Pushbutton (Depth & Current)	13
2.8 Alternate Locate Screens	14
3. Using the vLoc3-5000	18
3.1 Using the Receiver	18
3.2 Passive Locating	18
3.2.1 Detecting Power Signals	19
3.2.2 Detecting Radio Signals	20
3.3 Active Locating: Applying the Transmitter	20
3.3.1 Direct Connection	20
3.3.2 Signal Clamp (for frequencies above 8kHz)	21
3.3.3 Induction for frequencies above 8kHz	23
3.4 Locating Active Signals	24
3.5 Searching (sweeping) an Area in the Peak Mode	25
3.6 Searching (sweeping) an Area in the Omni-Peak Mode	25
3.7 Tracing a Buried Line	25
3.8 Depth & Current Measurement	25
3.9 Distorted Fields	26
3.10 Sonde-Location Mode	27
3.11 Signal Direction Precision Identification	28
3.12 Signal Select (SiS)	30

4.	Data Logging.....	33
4.1	Bluetooth	34
4.1.1	Fitting the Bluetooth Module.....	35
4.2	Pairing with external GPS/Dataloggers	35
4.3	Transferring Data from the vLoc3 Receiver to a Computer	36
4.3.1	MyLocator3.....	36
4.3.2	MyLocator3's Basic Operation.....	36
4.3.2.1	Updates Page	36
4.3.2.2	Application Update	37
4.3.2.3	Locator Firmware update	38
4.3.3	Toolbar	38
4.3.4	Data Logging 	39
4.3.5	Splash Screen 	40
4.3.6	Frequencies Page 	41
4.3.7	Menu Settings 	41
4.3.8	Advanced Features.....	42
4.3.8.1	Supervisor Lockouts	42
5.	Loc3-10SiSTx Transmitter	43
5.1	Loc3-10SiSTx Transmitter Overview.....	43
5.1.1	Display.....	43
5.1.2	Pushbuttons.....	43
5.1.3	Transmitter Information Pushbuttons.....	44
5.1.4	Transmitter Connections Block.....	44
5.2	Transmitter Batteries – Li-ion and Alkaline	45
5.2.1	Charging the Li-ion Battery Tray.....	45
5.2.2	Removing and Installing the Battery Tray.....	46
5.3	Transmitter Modes.....	46
5.3.1	Direct Connection Mode.....	46
5.3.2	Clamp Mode	47
5.3.3	Induction Mode	47
5.4	Transmitter Frequencies.....	48
5.4.1	Frequencies and Maximum Power Output	48
5.4.2	Most Used Frequencies (Frequency Selection) Feature	49
5.4.3	Multi-Frequency Mode for Direct Connection	50
5.5	Transmitter Link (TX-Link) 	51
6.	Using SiS Mode Accessories.....	54
6.1	Using the SiS (Signal Select™) Clamp	54
6.2	Using the vLoc3-5000 SiS Remote Antenna	55
6.3	Using the SiS Mode with the Remote Antenna.....	57
7.	Accessories & Options	61
7.1	Transmitter Signal Clamps	61
7.2	A-frame Fault Locator	61
7.3	vLoc3-MLA (Marker Locator Adapter)	61
8.	Glossary.....	62

1. Service & Support

1.1 Serial Number and Software Revision Number

When requesting product support, always quote your receiver and transmitter model number, serial number, and software revision number. They can be found as follows.



1. Model & Serial Number



NOTE

Software Revision Number: On both receiver and transmitter, the software revision number is displayed on the LCD during the startup sequence or found in the “About” section of the user menu.



Receivers with the **Tx-Link** option installed will show this icon label on the blade where it meets the yellow upper housing.

Transmitters with the **Tx-Link** option installed will show this icon label on the upper corner of the housing.

1.2 Worldwide Sales Offices and Service Centers

Worldwide Sales Offices and Service Centers	
<p>World Headquarters, United States of America Vivax-Metrotech Corporation 3251 Olcott Street, Santa Clara, CA 95054, USA T/Free: 1-800-446-3392 Tel: +1-408-734-3880 Fax: +1-408-904-4964 Website: www.vivax-metrotech.com Email: SalesUSA@vxmt.com</p>	<p>Central/South America and the Caribbean Ventas para América Latina 3251 Olcott Street, Santa Clara, CA 95054, USA T/Free: 1-800-446-3392 Tel: +1-408-734-3880 Fax: +1-408-743-5597 Website: www.vivax-metrotech.com Email: LatinSales@vxmt.com</p>
<p>Canada Vivax Canada Inc. 41 Courtland Ave Unit 8, Vaughan, ON L4K 3T3, Canada Tel: +1-289-846-3010 Fax: +1-905-752-0214 Website: www.vivax-metrotech.ca Email: SalesCA@vxmt.com</p>	<p>France Vivax-Metrotech SAS Technoparc - 1 allée du Moulin Berger, 69130 Ecully, France Tel: +33(0)4 72 53 03 03 Fax: +33(0)4 72 53 03 13 Website: www.vivax-metrotech.fr Email: SalesFR@vxmt.com</p>
<p>Germany Metrotech Vertriebs GmbH Am steinernen Kreuz 10a, 96110 Schesslitz, Germany Tel: +49 9542 77227-42 Website: www.vivax-metrotech.de Email: SalesEU@vxmt.com</p>	<p>United Kingdom Vivax-Metrotech Ltd. Unit 1, B/C Polden Business Centre, Bristol Road, Bridgwater, Somerset, TA6 4WA, UK Tel: +44(0)1793 822679 Website: www.vivax-metrotech.co.uk Email: SalesUK@vxmt.com</p>
<p>China Vivax-Metrotech (Shanghai) Ltd. Building 10, Lane 1158 Zhongxin Rd., Songjiang District, Shanghai, China, 201615 Tel: +86-21-5109-9980 Website: www.vivax-metrotech.com Email: SalesCN@vxmt.com.cn</p>	

2. vLoc3-5000 Receiver

2.1 vLoc3-5000 Receiver Overview

The vLoc3-5000 is a Precision Location System designed to meet the needs of utility companies and their contractors. The following describes the features and use of the receiver:

What's in the box:



- | | |
|----|--|
| 1. | vLoc3-5000 Receiver |
| 2. | Battery charger with power cord
*one of supplied based on geographical location |
| 3. | Li-ion battery |
| 4. | Alkaline battery holder |
| 5. | Mini-USB cable |
| 6. | User manual |
| 7. | Padded kit carry bag |

Compartments and Controls

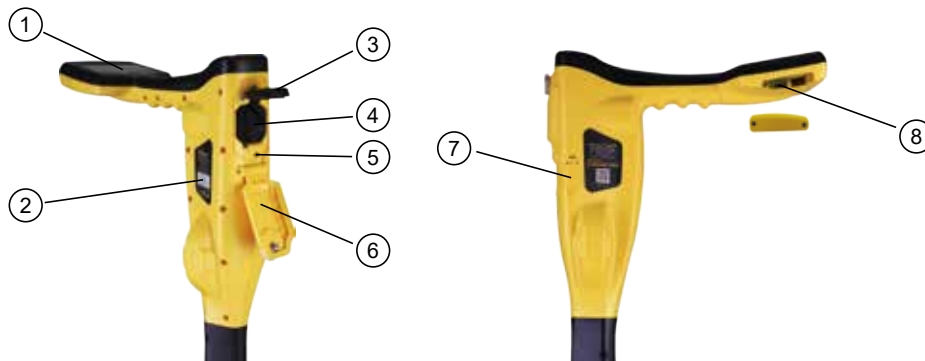

- | | | | |
|----|------------------------------------|----|-------------------------------|
| 1. | Pushbutton keypad and display | 5. | Mini-USB port |
| 2. | Model number & Serial number label | 6. | Battery compartment cover |
| 3. | Battery retaining cover | 7. | Charging and accessory socket |
| 4. | Battery compartment | 8. | Bluetooth expansion port |

2.2 Charging the Receiver Batteries

The vLoc3-5000 can be used with either alkaline batteries or an optional rechargeable battery pack.



The central illuminated section within the battery icon indicates the amount of charge remaining.

- Blue center indicates Alkaline batteries.
- Green center indicates rechargeable batteries.
- When batteries are low, the remaining charge section becomes red and will flash.

Just before the shutdown, the following symbol will be shown:



The optional rechargeable batteries are supplied with a mains charger. This is specific to the batteries. Avoid using other manufacturers' chargers as these may damage the battery pack and may result in overheating the battery pack.

To charge the rechargeable batteries, first make sure the pack is inserted in the receiver battery compartment as charging is done with the battery inside the receiver.



Connect the charger to the charging/Accessory socket of the receiver. Connect the charger to the mains and switch it on. The LED indicator on the charger will illuminate red until the batteries are fully charged, at which time the LED will change to green.



WARNING

Rechargeable batteries are supplied with a mains or 12V DC charger. The charger is specific to the battery. Only use the charger that is appropriate for the battery in the product. Failure to use the appropriate charger could damage the battery pack, locator and cause a fire in extreme cases. If in doubt, call the Vivax-Metrotech customer service department at +1 (800) 446-3392.

Avoid charging the unit in extreme temperature conditions, i.e., below 0°C and above 45°C.

Although Vivax-Metrotech batteries include all the required safety-related features, immediately discontinue the charger and battery pack's use if the battery pack becomes excessively warm. Return both to where they were purchased for investigation.

Always ensure batteries have at least a partial charge if stored for long periods without use.

Dispose of all batteries following your company procedures and or Federal/State and local regulations.

Never dismantle batteries, put them in a fire, or get them wet.

2.3 vLoc3-5000 Receiver Keypad

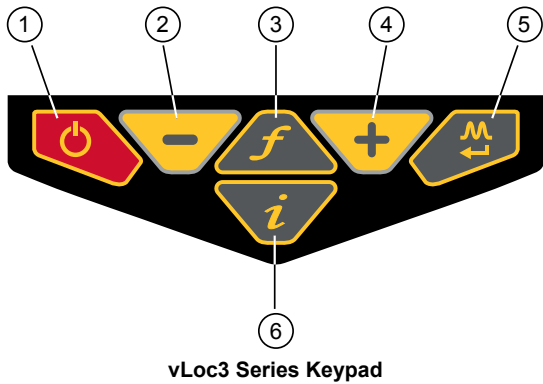

1. On/Off

2. Reduce sensitivity. (Also scroll up when in menu)

3. Select frequency
Long press = show the pre-selected frequency table

4. Increase sensitivity. (Also scroll down when in menu)

5. Enter Key
Short press = change antenna response when in classic screen
Long press = change the locate perspective

6. Information and Depth key
Short press = enter the information and logging screen
Long press = enter the menu

2.4 The vLoc3-5000 User Menu

The user-configurable vLoc3 series receivers can be customized to suit the user's preferences. The receivers have several features that can be switched on and off through the user menu.

This section covering the user menu is split into four subsections;

Setup – Covering the settings that are usually chosen and not often changed. Most of these settings apply to the locator's physical attributes such as language, sound, and measure units.

Operational – Covers the locate screens and locate perspective

Features – Are optional modes and physical add-ons such as Bluetooth, Marker Locator Adapter, and other options that may have been ordered.

Informational – Covers the receiver's configuration, firmware version, and regulatory information.

It is recommended that the **setup section** be done first. It will be easier to finish the receiver's setup if it is done in the native language.

To enter the user menu, press and hold the "i"  key, release the key when in the menu.

Note that where you see this symbol , pressing the enter button gives access to the sub-menu associated with this button.

To exit the menu or sub-menu, press the "i"  button.

Where the  icon is not shown, the enter button is used to scroll through the options of that feature.

Use the "+" and "-" buttons to scroll up and down through the menu.

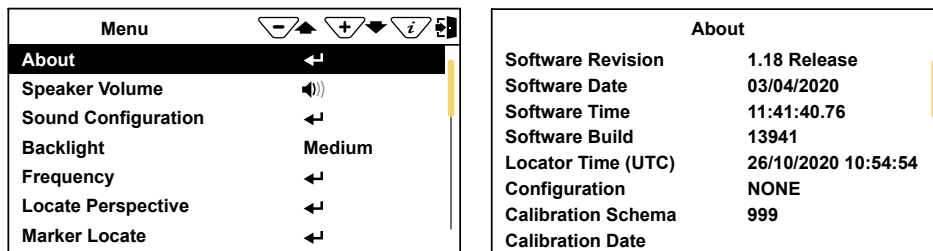

Main Menus

2.4.1 Setup - Receiver

Language – The receiver can be programmed in different languages. Repeatedly pressing the Enter key cycles through the list of available languages.

Speaker Volume – Repeatedly pressing the Enter key raises the speaker volume by three levels and then turns off the volume. When off  is displayed.

Backlight – Press the Enter key to change the backlight intensity to Low, Medium, High, or Auto. The use of the “Auto” selection is recommended because the receiver has a built-in light sensor that automatically adjusts the backlight intensity to the surrounding lighting conditions. Auto-selection may improve battery life performance.

Sound Configuration – Changes the sound configuration of the locate modes. Use the Enter key to select **AM** or **FM**.

- **When in active locate modes:**
 - Frequency Modulated (**FM**) Sound pitch changes with signal strength
 - Amplitude Modulated (**AM**) Sound volume changes with signal strength
- **When in passive locate modes:**
 - Radio mode: **FM or Real** (Sound derived directly from the received signal)
 - Power mode: **FM or Real**

Imperial/Metric – Use the Enter key to select Imperial or Metric measurements for the depth readings.

Continuous Info – The locate screens can display a continuous reading of either depth, current, both, or can be switched off. Use the Enter key to select your preference.

Auto Power Off – The unit can be set to switch off after a set time. Options are 5-minutes, 10-minutes, or Never. Note that when the accessory A-frame is connected, the timer defaults to “Never.”

2.4.2 Setup - Operational

Frequency – Press the Enter key to enter the Frequency sub-menu. Scroll up and down the table of available frequencies using the “+” and “-” keys.



TIP
Simplify the operation of the receiver by selecting only the frequencies applicable to your application. To do this, use the enter key to check the boxes on the right. Frequencies not checked will not appear on the locate screen.

Frequency	
8.01kHz	<input type="checkbox"/>
8.19kHz	<input checked="" type="checkbox"/>
8KFF	<input checked="" type="checkbox"/> A
8.44kHz	<input type="checkbox"/>
9.50kHz	<input type="checkbox"/>
9.80kHz	<input type="checkbox"/>
9.82kHz	<input checked="" type="checkbox"/>
10.0kHz	<input type="checkbox"/>



Note
Certain frequencies have an A-frame icon next to them. This icon indicates that these frequencies are selected to be used with the fault find A-frame.

Classic Locate – This option is only shown if the menu is entered from the Classic Screen. Use the enter key to reveal the list of options relating to the Classic Locate mode. Options are:

Classic Locate	
Peak	<input checked="" type="checkbox"/>
Peak With Arrows	<input checked="" type="checkbox"/>
Null	<input checked="" type="checkbox"/>
Broad	<input checked="" type="checkbox"/>
Delta Null	<input type="checkbox"/>
Omni Directional Peak	<input checked="" type="checkbox"/>
Omni Directional Broad	<input checked="" type="checkbox"/>

Locate Perspective – Enter this menu to select the graphical format that the locate data will be displayed. These displays are described further in the manual. The options are:

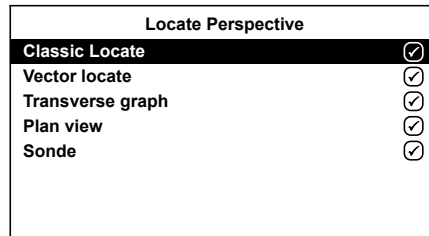

2.4.3 Setup - Features

Warnings – Warnings relating to - Shallow cable, Overload, Overhead cable, and Signal Overload. Scroll down to the relevant warning and use the return button to select or de-select.

Bluetooth Pairing (if installed) – This option allows the receiver to link with external devices such as data loggers and GPS devices with Bluetooth capability. Press the enter button to enter the Bluetooth pairing routine.

Bluetooth Auto Connect – When this option is enabled, the receiver will automatically connect with any previously paired Bluetooth device.

Transmitter Link – The Loc3 series transmitters can be remotely operated from the receiver. This option requires the Transmitter (radio) Link to be installed in both the vLoc3 series receiver and the Loc3 series transmitter. Tx-Link is a factory fit option that must be purchased at the time of ordering. Currently, the Tx-Link feature is **only available in the Loc3 series 5-watt and 10-watt** transmitters.

Transmitter Control - This feature is used to control a transmitter with the Radio Link activated remotely. For more information, see the section "Remote Operation of the transmitter."

DFT - Discrete Fourier Transform is a tool to help choose a frequency to apply to the target conductor. The DFT feature will aid the user with nearby interference that may affect the locate quality.

2.4.4 Setup - Informational

About - This section holds the data about the locator, such as software revision, calibration data, etc.

Regulatory Labels - This section shows the required FCC ID and IC information.

Self-Test - The vLoc3 series receivers have a self-test feature that confirms the equipment is fit for use and that the calibration has not drifted from its expected settings.

2.4.5 Self-Test

The Self-Test feature must be run in an area free from interference, such as overhead fluorescent lighting, large transformers, etc. Also, check that any nearby transmitters or sondes are switched off.

Select "Self-Test" from the user menu and press the "Return" button. Keep the receiver stationary while the test is running. After a short while, the test will complete, and the unit will report Passed or Failed.



Examples of the Self-Test results

If the receiver fails the test, try again in an area with less interference. If it continues to fail, return the unit to Vivax-Metrotech or one of its approved service centers for investigation.

2.5 Warnings and Alerts

Warning symbols are shown on the display and accompanied by an audible sound and vibration in the handle unless configured otherwise in the MyLocator3 desktop app. Warnings can also be switched off in the setup menu.

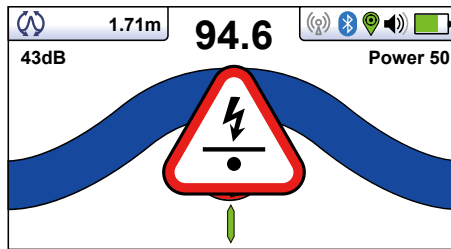

Warning icons shown on the display

2.5.1 Warnings and Alerts Descriptions

ALERT	Alert Description
	Signal Overload - is usually caused by operating close to power transformers or being close to a transmitter in Induction mode. Moving away from the interfering signal will solve the problem.
	Shallow Cable - alerts indicate that the locator has detected a possibly less than 15cm (5.9-inch) deep cable. Proceed with caution.
	Swing Alert - indicates that the operator is swinging the locator excessively, resulting in misleading information. When sweeping the locator across the direction of the line, try to keep it vertical; this will improve its accuracy.
	Overhead Cable - alerts indicate that the source of the signal is mainly radiating from above. This alert is usually caused by the signal traveling along overhead cables.

2.5.2 DFT (Discrete Fourier Transform)

DFT is a tool to assist in choosing a frequency to apply to the target conductor. The DFT feature will aid the user with nearby interference that may affect the locate quality.



***Note the DFT feature should not solely be used to determine which frequency to apply. ALWAYS follow the appropriate safety requirements mandated by safety legislation, safety practice, or your company's safety procedures when applying a locate frequency to a conductor.**

- To perform a DFT assessment, verify any nearby transmitters are powered off to avoid additional signal frequency disturbance.
- Select your preferred frequencies from the frequency menu. These selected frequencies will be assessed in the next few steps.

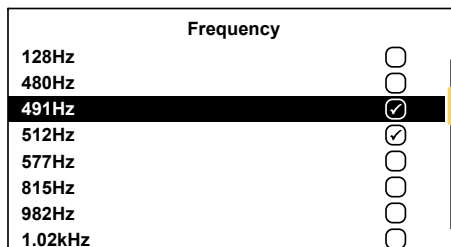

- Navigate to the main menu and scroll until you see DFT. Select DFT by pressing the enter key.

2 vLoc3-5000 Receiver

- Once the option is selected, the receiver will automatically assess the user's preselected frequencies.
- The receiver will scan all available frequencies and display a progress bar and the list of frequencies assessed will be displayed. The frequency under test is shown on the top line.

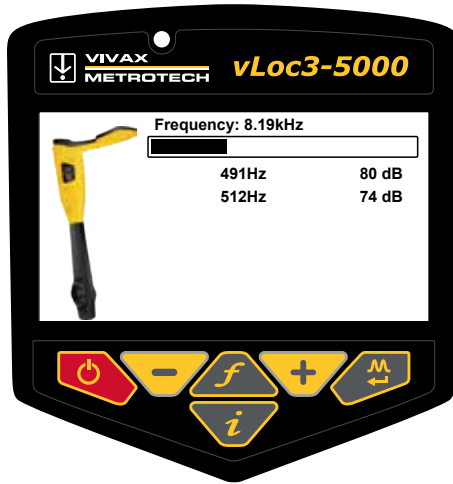

Scan in progress

- A numerical value ranging from 0dB to 140dB will be shown next to the frequency list with 140dB being the least possible interference detected and 0db with the largest amount of possible interference.
- The results are ranked from the least interference possible at the top to the largest amount of most possible interference at the bottom.
- In this case, the higher the dB number (80dB), the less interference has been detected by the receiver.

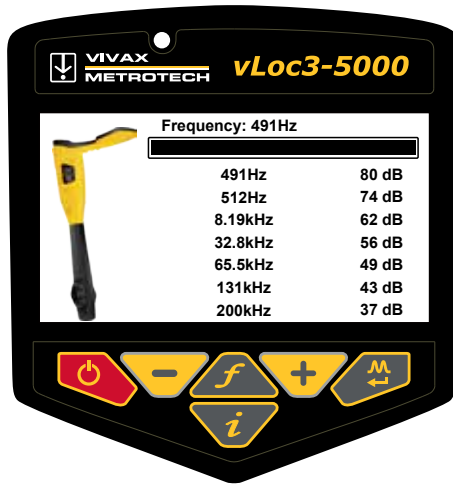

Although frequency results appear to have less interference, it still is not the best choice to locate certain utilities. These include but are not limited to a conductor, current output, resistance, and signal bleed over adjacent utilities.

2.5.3 vLoc3 Series Locate Modes and Screens

Note - The vLoc3 series user interface is under continual development. The screenshots described here may differ slightly from your screens.

The vLoc3 series receivers give the user a choice of locating screens.

The choice of the screen depends on the application and user preference. These screens are:

- vLoc3-5000 Classic Locate
- vLoc3-Pro Classic Locate
- Plan View Locate
- Vector Locate
- Transverse Plat Locate
- Sonde Locate

The vLoc3-5000 receiver gives the user a choice of two Classic Locate screens. They are the vLoc3-5000 classic screen and the vLoc3-Pro classic screen.

This manual will first explain the functions of the "Classic Screens" as familiarity of these screen will help understand the functions of the others.

2.5.4 The Classic Screen Status Bar

All vLoc3 series screens have a status bar at the top indicating various locator settings.

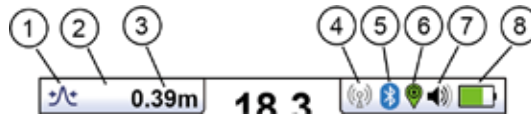

The vLoc3 Series Status Bar

1. Antenna configuration (meter response) described later in the manual

2. Other future option

3. Signal Current/Depth to the target line. (Can also be set to display signal current on the line or both)

4. Transmitter Link connection status (see section 5.5)

5. Bluetooth status (If Transmitter link is fitted this icon  will replace the blue tooth icon as they are mutually exclusive)

6. GPS status (see below for further explanation)

7. Speaker volume setting

8. Battery type and remaining charge

2.5.5 The Classic Screen

The vLoc3-5000 Classic Screen has all the functions normally seen on a classic cable locator. The main functions are:

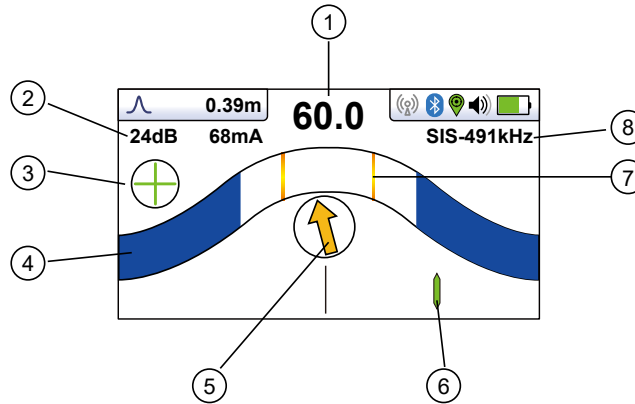

1. Percentage signal strength (mirrors the bar graph setting)

2. Gain setting

3. Only visible with SiS frequencies, "+" indicates correct line, "-" indicates incorrect line

4. Bar graph signal indicator (changes color depending on distortion level)
Green - Low distortion
Blue - Minor distortion, proceed with care
Red - Excessive distortion, treat all data and measurements with caution

5. Compass line direction indicator (when using an SiS frequency, arrow points forward on correct line, it will reverse on incorrect line)

6. Line position indicator

7. Peak level indicator

8. Frequency selection (flashing frequency indicates frequency selection is not valid for this screen. Choose another frequency)



Tip
 When in a locate screen, pressing and holding the "f" key will bring up the frequency table. Use the "+" and "-" keys to navigate quickly to the desired frequency. Press the "i" key to select a highlighted choice and return to the locate screen.

Radio
SD-EUR
8kHz
8KFF
33kHz
83kHz
200kHz

2.6 Classic Locating Modes (Response)

The vLoc3-5000 receiver has an array of six antennas, and these can be toggled through different configurations (modes) to provide different responses to the signals radiating from buried utilities. The modes are:

2.6.1 Peak Response Mode

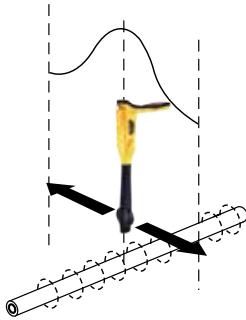

Two horizontal antennas provide a “Peak” or maximum signal response over the center of the buried line. The compass (line direction indicator) aligns itself parallel to the direction of the cable together with a line position indicator showing which side of the line the locator is (available in Active modes).

This is an accurate method of the locating as both horizontal antennas are used to provide a clearly identifiable “Peak”. It is also less prone to the effects of signal distortion.

A Peak Level Indicator is also provided on the bar graph. This indicates the largest signal detected allowing the user to quickly return to this point.

2.6.2 Broad-Peak Mode

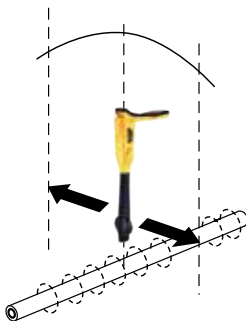

This uses a single horizontal antenna and provides a “Peak” or maximum signal response over the center of the buried line. The compass (line direction indicator) aligns itself parallel to the direction of the cable together with a line position indicator showing which side of the line the locator is (available in Active modes).

This gives a less defined peak than the twin horizontal antenna “Peak” mode – but is useful in some situations such as deep lines because using a single antenna has the effect of boosting the received signal.

2.6.3 Null Mode

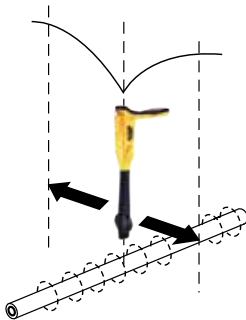

This uses vertical antennas and provides a minimum or “Null” response over the center of the buried line.

The compass (line direction indicator) aligns itself parallel to the direction of the cable together with a line position indicator showing which side of the line the locator is (available in Active modes).

The null mode works well in uncongested areas but is more prone to inaccuracies because of field distortion. This effect can be utilised to detect the presence of distorted fields. Compare the locate position “Null Mode” with the position “Peak Mode”. If the two positions do not coincide, this indicates possible distortion. The greater the difference the greater the distortion.

Left/right indication arrows are also displayed when in “Null” mode. The arrows indicate the direction to move the receiver to locate the position of the buried line.

2.6.4 Delta Null

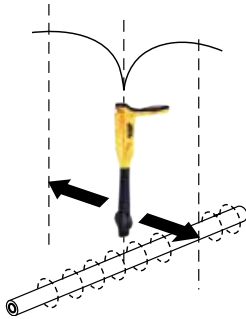

This uses dual vertical antennas. This has the advantage that it provides a sharper response than the “null” mode and is less affected by distorted fields. All other functions are the same as the “Null” mode.

2.6.5 Omni-Peak Response Mode

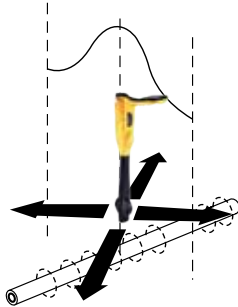

When you see the two double ended arrows around an icon, this means that the line is detectable regardless of locator blade orientation. It is very useful for quickly checking an area for buried lines using a grid search as one sweep will catch all locatable lines. In the classic screen the Omni feature is available in the “Peak” and “Broad Peak” modes.

The compass and line position indicators are also shown when the double arrow icon is shown.

2.7 Information Pushbutton (Depth & Current)

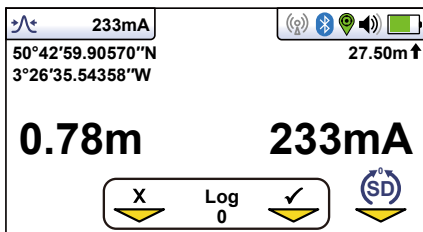

When in a Locate screen, a quick press of the “f” (information) pushbutton will display the depth and signal current.

The top left of the display shows Longitude/Latitude positional information. To the top right is the height above sea level. This information will only appear when the receiver is paired with a GPS module that is receiving a signal.

It is also possible to save the data to the internal memory; see the “Datalogging” section of this manual.



IMPORTANT

When locating a cable or pipe (“line”) – depth and current measurements should only be taken with the bottom of the receiver standing on the ground and directly in line with the target line. Unless the  Omni-direction mode is selected in which case orientation is not important.

The accuracy of depth and current readings depends on the quality of the radiated signal being located. If the signal is undistorted, the depth reading will be accurate to within 3%. The accuracy also depends on the care taken in pinpointing the line. A more accurate pinpoint, results in better depth and current measurements.

The SiS icon indicates which button to press to temporally reset the SiS signal reference. This is not normally necessary but is explained in the SiS/SD section.

2.8 Alternate Locate Screens

As previously mentioned, the vLoc3 series receivers have alternative locate screens. The following section describes the operation of these screens. It is left to the user to decide which is the best screen for a particular application.

To scroll through the available screens use a long key press on the Return key.

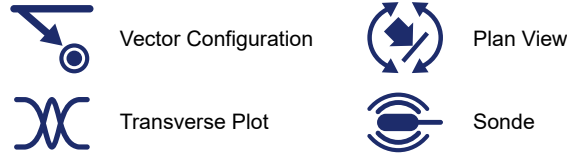

Vector Screen

The Vector Screen shows a cross sectional view through the ground. A plan view is also shown to help orientate the user over the line. The Vector Screen is particularly useful where access directly over the line is not possible. Depth and horizontal displacement distances are shown, even when not directly over the line.

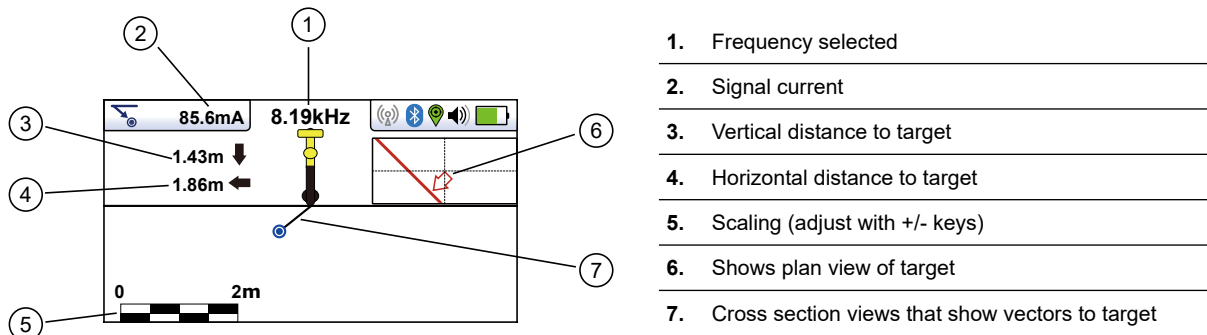

1. Frequency selected

2. Signal current

3. Vertical distance to target

4. Horizontal distance to target

5. Scaling (adjust with +/- keys)

6. Shows plan view of target

7. Cross section views that show vectors to target

Using the Vector screen

1. Apply the signal to the target line in the usual way and select the vector screen by using long presses on the “return” button until the desired screen appears.
2. Position the locator within the approximate position of the target line. Use the plan view to help guide you towards the target line. You can imagine that the plan view is giving you a view into the ground.
3. Position yourself so that the red target line is pointing forward/back and is centralized on the screen.

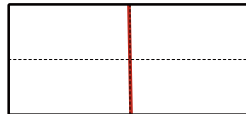

4. If the target is off the screen an arrow will appear on the screen to help direct you to the target line.

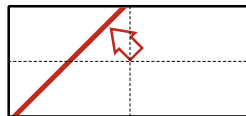

5. The cross-sectional section of the screen will respond as the target is approached. Use the “+” and “-“ keys to alter the scaling if necessary.
6. There is a black line leading from the locator to the target line. The target is represented by a blue dot. Around the dot is a circle, the size of the circle indicates a confidence factor. The larger the circle the less confident the indicated position. Generally, the actual position of the line will be within the confidence circle.

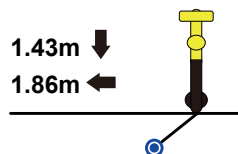

2 vLoc3-5000 Receiver

The color of the confidence circle also changes depending on the degree of confidence:

Green: - Low distortion/high confidence.

Blue: - Minor distortion/medium confidence, proceed with care.

Red: - Excessive distortion/low confidence, treat all data and measurements with caution.

- Notice that vertical and horizontal distances from the target line are displayed.

1.43m ↓
1.86m ←

This must not be mistaken for the distance diagonally to the target, this information is not displayed. The vertical distance is the true depth from the bottom of the locator. The advantage of this is that the depth and position of the target can be determined without being directly over the target line. So, in the event of an obstruction at the measuring point, data can still be gathered by placing the locator to one side of the target.

Plan View Screen

The Plan-View Screen shows a picture as if you were viewing the line from above ground. When the line is in the center and pointing forward/back then you are directly over the line and pointing in the direction of the line.

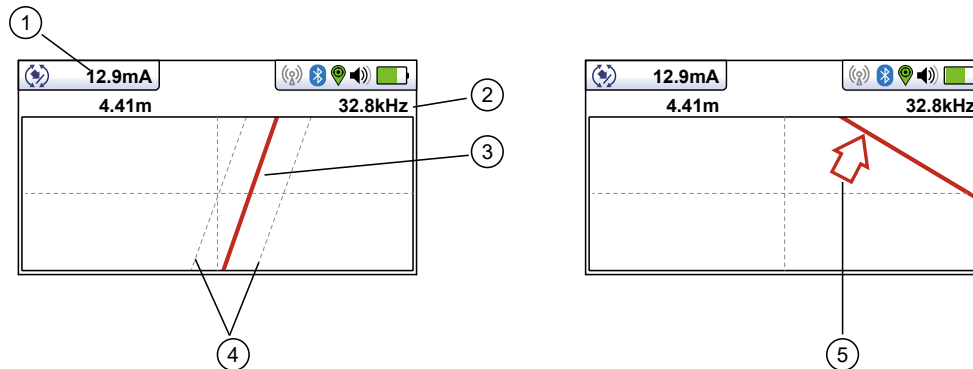

- Depth and current readings
- Frequency selected
- Target line
- Lines of confidence (closer these are to the target line indicates more confidence)
- Arrow indicates direction to move towards line. It only shows when the distance to the target line is far away

Using the Plan-View screen

- Apply the signal to the target line in the usual way and select the Plan-View screen by using long presses on the return button until the desired screen appears.
- Position the locator within the approximate position of the target line. Use the plan view to help guide you towards the target line. You can imagine that the plan view is giving you a view into the ground.
- Position yourself so that the target line is pointing forward/back and is centralized on the screen.

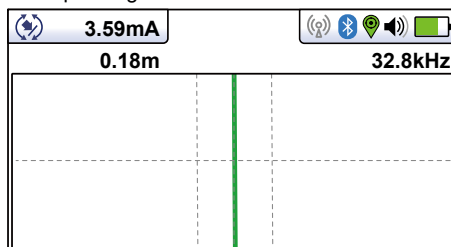

"Tram" lines either side of the line indicate an area of confidence. The closer the tram lines are together the greater the confidence.

2 vLoc3-5000 Receiver

In addition to the tram lines, the color of the target line also changes depending on the degree of confidence:

Green: - Low distortion/high confidence.

Blue: - Minor distortion/medium confidence, proceed with care.

Red: - Excessive distortion/low confidence, treat all data and measurements with caution.

4. If the target is off the screen an arrow will appear on the screen to help direct you to the target line.

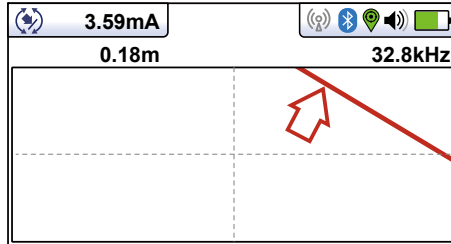

5. As long as the locator is detecting a valid signal, the depth (or current) will be available regardless of locator orientation i.e. the locator does not need to be aligned with the target line in the forward back orientation. It is recommended that, in this mode, the current is always displayed as it is possible signal will bleed off onto other services. Regular checks on the signal current i.e. checking for large changes, will ensure the correct line is detected.

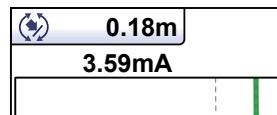

6. A short press on the info button will display the Information Screen. More information relating to the Information Screen is described in a previous section "Information Pushbutton (Depth & Current)".

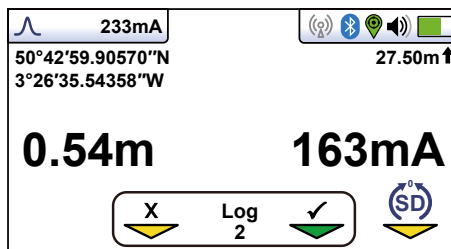

Transverse-Plot Screen

The Transverse-Plot screen is used to analyze the field shape at a particular location. This enables the user to get a better feel for the reliability of the data gathered.

Two plots are generated simultaneously.

- Peak response
- Null response

In non-distorted fields, the peak and null positions should coincide and the shape of the fields should be symmetrical about the center line. The picture below shows a slightly distorted field.

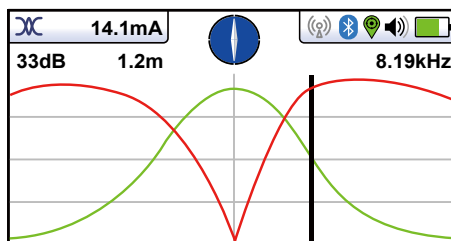

To take a plot first locate the target using one of the other locate screens. Now select the Transverse Screen by a prolonged press of the return button. Repeat this until the Transverse screen appears.

2 vLoc3-5000 Receiver

Position yourself to one side of the line such that the field markers are just on the screen. You will see that the lines automatically remove themselves after a set period of a few seconds. Clear the screen by pressing the “-” button. Now walk across the line of the target at a steady pace until you are on the other side of the target line. Immediately press the “+” button to save the plot on the screen.

It is still possible to walk back over the target, locating the position of the line when in the transverse screen while still retaining the saved screen.



3. Using the vLoc3-5000

3.1 Using the Receiver

Line locating using the "Classic" screens.

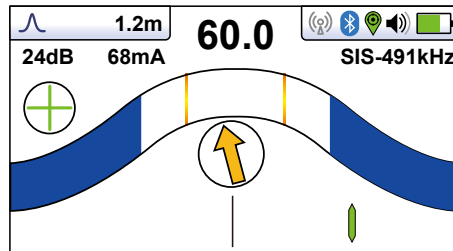

3.2 Passive Locating



NOTE

The compass indicator is not active during passive location.

Passive locating refers to the process of detecting signals that "naturally" occur on pipes and cables. These tend to fall into two categories, radio signals and power signals.

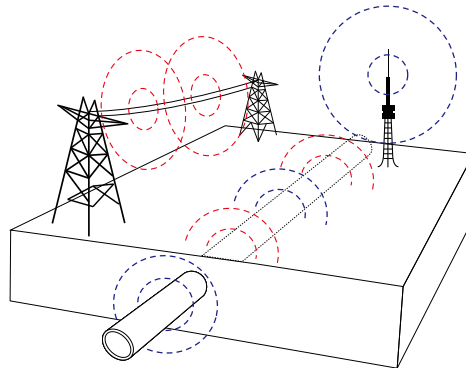

Radio signals are created by low frequency radio transmitters. These are used for broadcasting and communications. They are positioned throughout the world. As the frequencies are very low the signals tend to penetrate and hug the curvature of the earth. When the signals cross a long conductor such as a pipe or cable, the signals are re-radiated. It is these re-radiated signals that can be detected by the Radio mode.

Power signals are created by mains power running in the supply cables. These signals are 50 or 60Hz depending on country. For instance, the UK is 50Hz power but in the USA has 60Hz. When electrical power is distributed throughout the network, some of the power finds its way back to the power station via the ground. These stray currents can jump onto pipes and cables and also create power signals. Note that there has to be electrical current flowing to create a detectable signal. For instance, a live cable that is not in use may not radiate a detectable signal. Also, a very well-balanced cable, i.e. exactly the same current flowing in live and neutral, will cancel out and may not create a signal. In practice this is unusual as there is usually enough imbalances in the cable to create a good detectable signal.

3 Using the vLoc3-5000

3.2.1 Detecting Power Signals

1. Switch on the vLoc3-5000 receiver and select Power mode using the “f” button. Notice that the antenna mode indicator will be showing “Peak” or “Omni-Peak” as these are the only options in the passive modes.

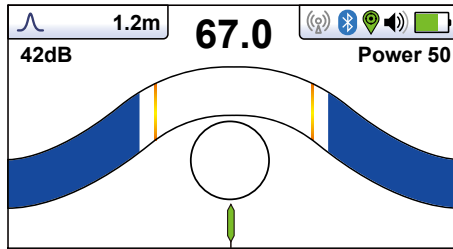

2. Hold the vLoc3-5000 vertically and away from likely positions of cables or pipes.
3. Adjust the sensitivity using the “+” and “-” buttons so that the bar graph reading is just starting to show some movement. Note that the compass and line position indicator features are not available for the Power or Radio modes.



NOTE

Note that there will be no sound from the speaker until the meter reading is above approximately 10% of full scale.

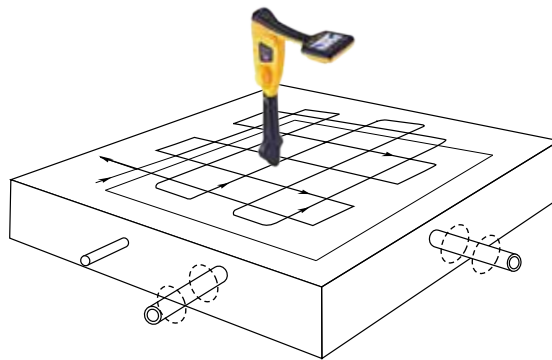

4. Keeping the vLoc3-5000 vertical, walk across the area to be checked keeping the orientation so that the blade is in line with the direction of walking (see diagram above) If using the Omni-Peak mode, the orientation of the locator is not important.
5. Continue in a grid across the area.
6. If at any time, the meter reading starts to increase, carefully move the locator side to side to detect the maximum signal. Use the Peak Level indicator to help confirm the correct position.

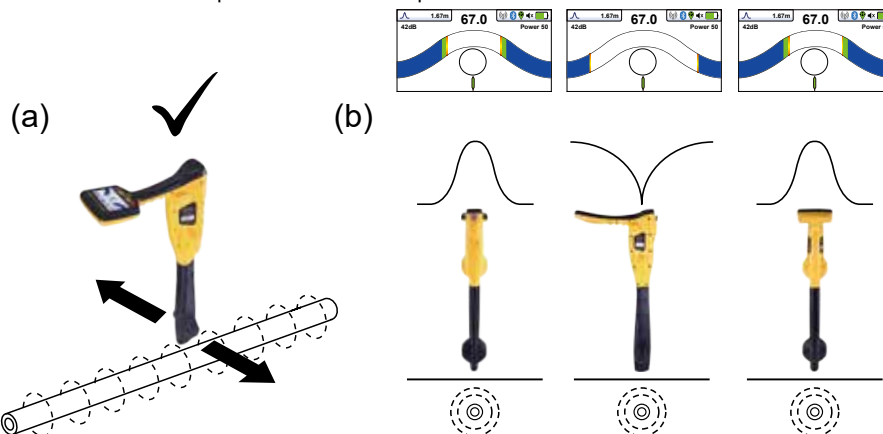

7. Rotate the vLoc3-5000 on its axis to obtain the maximum signal. The vLoc3-5000 is now directly over the line and with the blade across the line (if using the Omni-Peak mode there will be no change so switch to Peak mode if the direction is required).
8. The direction can also be found by rotating until the smallest signal is detected. The blade is then in line with the cable/pipe.
9. Continue to locate the position of the line at regular intervals until its course is known through the target area.

3.2.2 Detecting Radio Signals

1. Locating Radio signals is very similar to detecting Power signals as they are both passive signals.
2. Hold the vLoc3-5000 vertically and away from likely positions of cables or pipes.
3. Adjust the sensitivity control so that the bar graph reading is just starting to show some movement. Now follow the procedure described above in the Power mode section.

3.3 Active Locating: Applying the Transmitter

Active locating uses a transmitter to apply a precise frequency to a pipe or cable, then uses a receiver turned to detect the signal being radiated at that precise frequency. Active location frequencies can be applied by direct connection, signal clamp or induction (this is further explained in the following sections).

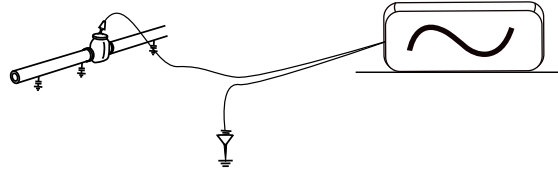

Active locating has the benefit that, unlike passive detecting, the operator is in control of the signals and therefore can be more specific about what line is detected. That is to say active signals can be used for line tracing. Also, passive signals are not always present on a line so using active signals ensures more lines are detected.

Choosing the correct frequency will depend on the application but as a general rule, select low frequencies as these tend to “bleed off” less than higher frequencies. A good general-purpose frequency is 33kHz and is a good starting point if in doubt.

When using “Induction” or the “Signal Clamp”, the frequencies available are limited to a set of frequencies optimised for the equipment. The full range of frequencies is available in “Direct Connection” mode.

For frequencies below 45 kHz, authorities such as the FCC allow higher power output to be used; for frequencies of 45 kHz and above, power output for this type of equipment is restricted to 1 watt. Therefore, more power is available when lower frequencies are used.

To inject a signal requires the use of a transmitter. The signal can be injected, or applied, to the target line in a variety of ways.

3.3.1 Direct Connection

This method involves making an electrical connection to the cable or pipe.



WARNING

When connecting to a cable, only connect to the sheath of that cable. The direct connection leads are not designed for connection to live cables.



WARNING

Do not touch metal parts of the connection clips when connecting to the line or when the transmitter is on.

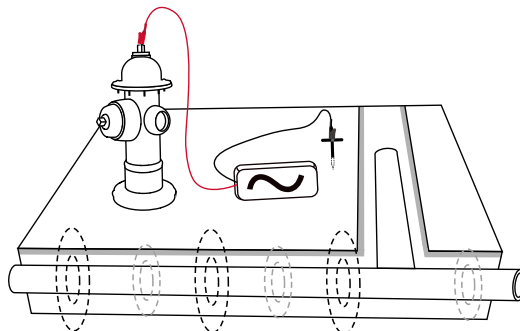



WARNING
Only authorized personnel should make connections to cables.

To make a direct connection, insert the direct connection connector to the transmitter. Insert the ground stake into the ground a few meters perpendicular to the line. Connect the black lead to the ground stake. Now take the red lead and connect to the target line.

Switch on the transmitter by pressing and holding the on/off button down for a couple of seconds. Select the desired frequency depending on the application. Check for a good connection by either noting the mA output on the display or noting the change in tone rate when disconnecting and then reconnecting the red lead. (depending on the transmitter model)

Things that can affect the quality of connection are:

1. Rusty pipe connection point: clean the connection area with a wire brush.
2. Poor grounding: try inserting the stake into damp ground. Dampen the surrounding ground with water. If still an issue, try connecting to a manhole cover surround. Avoid connecting to fence railings as these may create return signal currents along the fencing that will interfere with the locating signal.

Always start with a low output and increase the output if the received signal is not strong enough. Setting the output to high when it is not required may result in some of the signal “bleeding off” onto other services and will drain more power than necessary from the battery.

When connecting to a ferrous material, it is sometimes not possible to find a suitable projection to apply the connection clip. If this is the case, use the optional magnet to make contact to the line and then clip the red clip to the magnet. A good example of this is to make a connection to a street lighting circuit. Usually it is the practice to connect the sheath of a lighting cable to the metallic inspection cover of a street lamp. Making a connection to the inspection plate will energize the cable via the plate and sheath. Usually there is no projection on the plate on which to clip, so using the magnet on the plate provides a suitable clipping point.

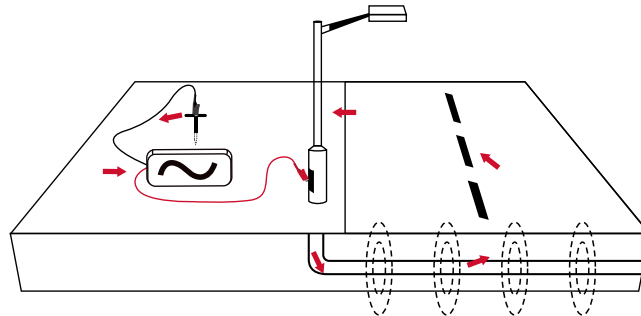

3.3.2 Signal Clamp (for frequencies above 8kHz)

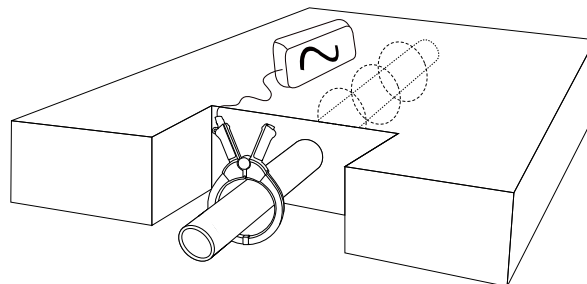

In many situations, it is not possible to gain access to a cable to make an electrical contact. Or if there is, it is not safe to do so. The signal clamp provides an efficient and safe method of applying a locate signal to a cable. Note that for best results the cable should be grounded at both ends.

3 Using the vLoc3-5000

When clamping around a cable make sure the clamp is placed below the grounding point and the two halves of the clamp are completely closed, as shown below.

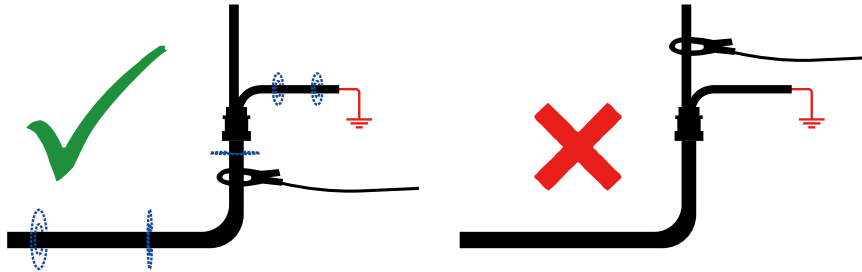

When applying a clamp close to a grounding point where multiple grounds or a grounding bus exists, ensure that you place the clamp around the target line and not to the ground bus/other grounds. This will help focus the applied signal to the target line.

Tip

The clamp should be closed for optimal current induction. However, if it is not possible to fully close the clamp, a small amount of current will still be induced into the line.

Clamp Extension Rod

A useful accessory to the clamp is the extension rod:

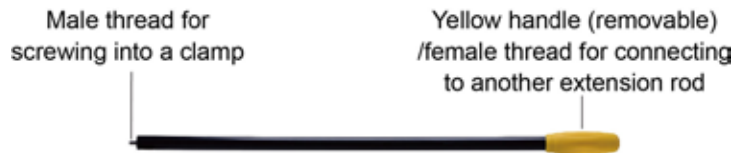

The extension rod is fitted with a 10mm threaded male stud. This male thread screws into the handle of the signal clamp to extend the distance of the clamp. This is helpful in areas with difficult access such as in manholes or overhead cables (not to be used on uninsulated overhead power cables).

The extension rod is also fitted with a female thread in the handle which enables the rods to be fitted together to further extend the range. To access this thread, slide the yellow handle off the extension rod.

To operate the clamp jaws when attached to the rod, gently pull on the clamp cord which will open the jaws. Release cable to close them.



WARNING

ALWAYS follow the appropriate safety requirements mandated by safety legislation, safety practice or your company's safety procedures when applying a clamp (coupler) to a cable.



BEWARE that when placing a clamp around cables carrying high current, the clamp may vibrate, jump or close violently due to inducted current from the target cable.

In some situations, high voltages can be induced back onto the clamp and be present at the clamp's plug. Safety practices should be followed all times when clamping around live target lines!

In all situations ensure the clamp is connected to the transmitter before clamping around a line.

3.3.3 Induction for frequencies above 8kHz

With no direct connection lead or signal clamp connected, the transmitter will automatically start to radiate a signal around the transmitter. These signals will penetrate the ground and couple onto buried lines. The signal will then travel along the line which can be detected with the vLoc3-5000 locator.

Applying an induction signal to a line.

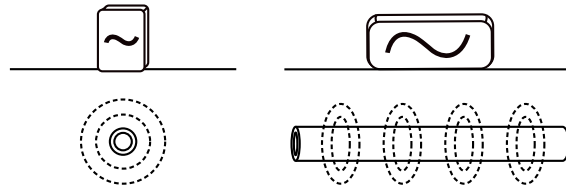

Remove any connections from the output connector. Switch on the transmitter and place it over the suspected position of the line and position it so that it is in line of the target as above. In the case of the Loc3-10SiSTx that is with the handle pointing along the line and in the case of the Loc-5STx arrows printed on the labels should point along the line of the target line.

The induction mode is particularly useful where there is no access to the line, but it should be noted that this is the least efficient method of applying a signal and it is also prone to signals being applied to adjacent lines.

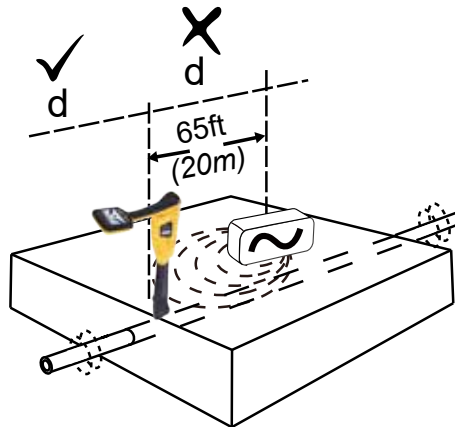

Also note that the signal will radiate out to the side of the transmitter as well as below. For this reason, it is recommended that when applying a signal using the induction method, a distance of at least 20m is kept from the transmitter when pinpointing or taking depth readings. Locating closer than 20m is possible but the operator should be aware that the signal directly received from the transmitter may be strong enough to influence the results.

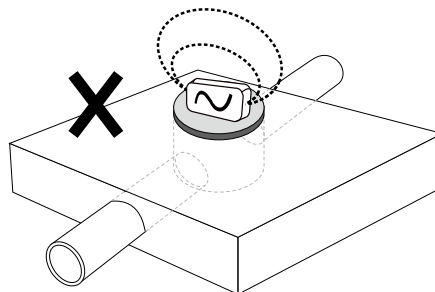

When using the induction mode, avoid placing the transmitter over metallic manhole covers as this will severely reduce the effectiveness of the transmitter and in extreme cases cause damage to the transmitter's circuitry.

3.4 Locating Active Signals

These instructions assume that the Classic Screen is selected and Peak with Arrows mode is selected for the antenna configuration.

1. With a transmitter, apply an active locate signal to the line.
2. Set the receiver to Peak with Arrows
3. Match the frequency of the receiver to that of the transmitter.

Note that the screen will now show the addition of a compass (line direction indicator). In the presence of a locate signal the compass will align itself parallel to the line being located. The compass helps to ensure that the operator is aware of the direction of the line.

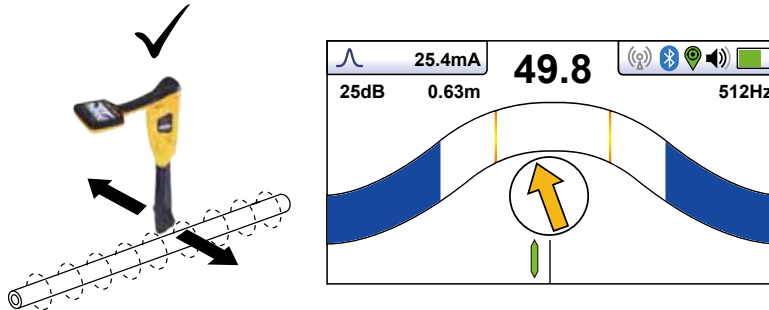

Hold the locator vertically and rotate it on its axis until the compass indicates Forward/Back, as shown above.

Adjust the sensitivity control so that the display indicates approximately 50%. Keeping the vLoc3 receiver vertical move to the side slightly. If the bar graph increases, you are moving toward the line. If it decreases, you are walking away from it. Move toward the line as indicated by the direction arrows until a maximum signal is achieved. It may be necessary to reduce the sensitivity to keep the bar graph on the scale. This is a normal occurrence and should be expected. Try to keep the vLoc3 receiver vertical and avoid swinging it, as this may create false readings.

Move the locator side to side to ensure a maximum signal is detected. Use the peak level indicator to assist.

With the maximum signal found and the compass running Forward/Back the vLoc3 receiver is now directly over the line and exactly across it.

If the signal is not distorted and the maximum signal's position will coincide with the position as indicated by the arrows. If these two positions do not agree it may be because there is signal distortion. Treat the results with caution.

Continue to trace the line to its destination or source.

If you have selected the Omni-Peak antenna configuration arrows will not appear on either side of the compass. This is because when in Omni mode the line can be detected from any direction.



When in a locate screen, pressing and holding the “f” key will bring up the frequency table.

Power 50
Power 60
Radio
491Hz
512Hz
8.19kHz
8KFF
9.82kHz
32.8kHz

Use the “+” and “-” keys to navigate quickly to the desired frequency. Press the “i” key to select a highlighted choice and return to the locate screen.

3.5 Searching (sweeping) an Area in the Peak Mode

Buried utilities may be parallel to each other and frequently they cross the area being searched at various angles and depths.

As the locator antennas response is directional (using the traditional screen), it is important to search the area in the same or similar pattern as shown. This orients the antennas in a way that will locate any signals being radiated from the buried utility.

Once a response is found, trace pinpoint and mark the utility. Searching an area in this way is generally but not exclusively done in the Peak mode using passive locating.

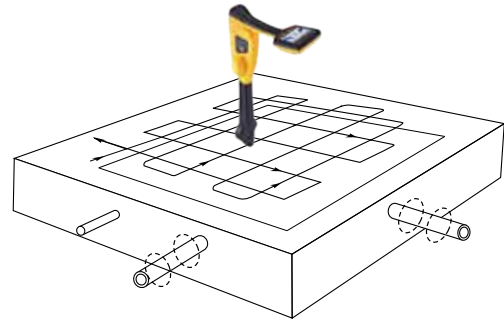

3.6 Searching (sweeping) an Area in the Omni-Peak Mode

Searching in the Omni-Peak mode is very similar to the Peak mode, except that it is only necessary to sweep an area in one direction. A zig-zag motion is enough rather than a full grid action because the locator will respond to a signal from a line in any direction. It has the benefit of cutting the sweep time in half.

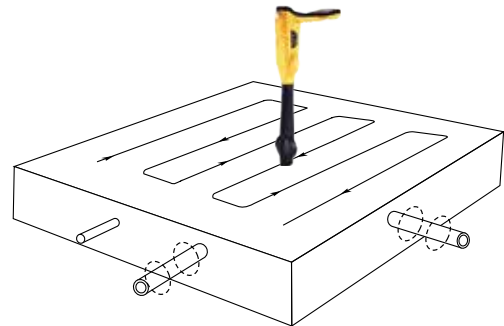

3.7 Tracing a Buried Line

Where possible trace out from the transmitter connection point. Having pinpointed the line, hold the locator vertically and in front of you with the compass line indicator pointing forward/back. Start by moving the locator left to right/right to left over the line. Keep the movement over the center of the line, i.e., the largest meter response, adjusting the gain when necessary. Whenever practical it should be traced to the point that provides additional confirmation of what type of service is being located, i.e. a telephone pedestal, a manhole cover, etc.

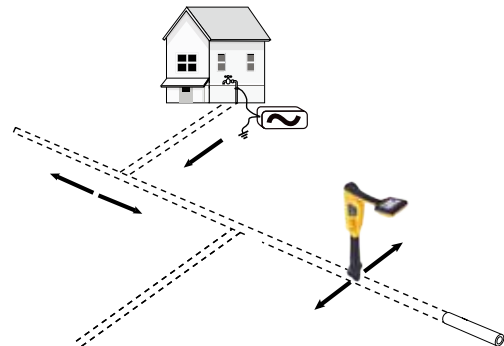

3.8 Depth & Current Measurement

If the depth measurement feature is activated it is possible to take depth measurement estimations. To take a depth measurement first pinpoint the position of the line. Place the vLoc3 receiver's tip on the ground, making sure it is vertical and across the line, i.e., the compass indicating Forward/Back. Momentarily press the "i" button. The screen will change to a screen similar to the one to the right.

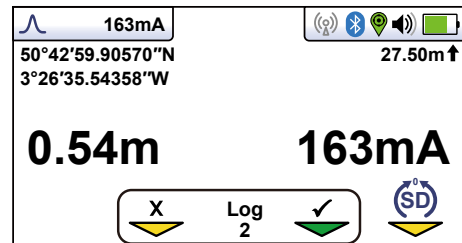

If Omni mode is selected, the locator's orientation is not important, but it is still necessary to pinpoint the line accurately before taking a depth measurement.

3 Using the vLoc3-5000

When taking a depth reading the signal current value will also be displayed. This feature is useful for confirming that the detected signal is radiating from the correct line. If the signal is bleeding off onto other services these signals will generally be less than that of the originating signal. However, care should be taken as the signal current will gradually reduce over the length of the line. Watching for a sudden drop in current over distance should indicate that either:

1. There is a ground fault on the line which is a shunting signal to ground.
2. There is a Tee off from the mainline.
3. The operator has migrated from the connected line to a line with some signal bled across from the mainline.

3.9 Distorted Fields

Always be aware that you are locating the signals radiating from the buried line. These radiated fields can be distorted by other lines or electromagnetic signals from buried lines. Metallic structures like crash barriers or wire mesh fences can also help to distort signals.

vLoc3 series receivers can detect the presence of possible distortion. The Vector screen has a circle drawn around the target line, which increases in size in the presence of possible distortion. The Plan view screen has "Tram" lines on either side of the calculated position, which moves further from the line as possible distortion is detected.

However, when using the traditional screen the risk of an inaccurate location can be reduced further by doing the following:

- Check to see if other radiated fields are distorting the signal. Locate the cable, first in the Peak mode and then in the Null mode or use the left/right arrows. The two locations should indicate that the cable is in the same place. If they do not, the signal field is distorted, and the depth and current measurement may be inaccurate.

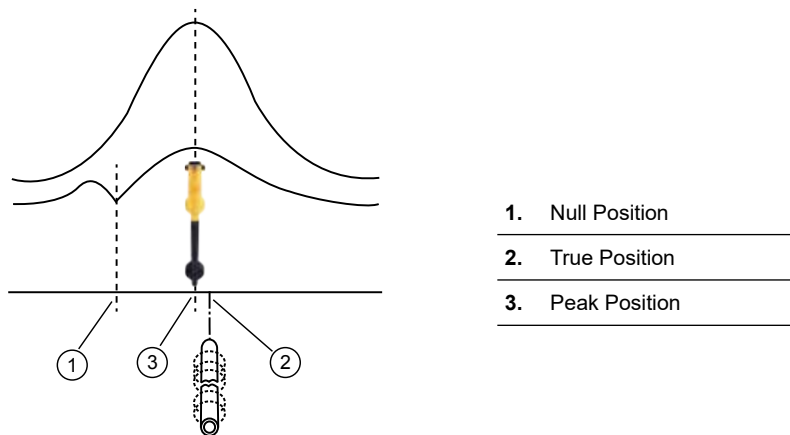

- Measure the buried line's depth by briefly pressing the "i" pushbutton to measure depth and current. The depth should be approximately in line with the "as-built" plans available. If no plans are available, logic would still help assess the situation (for instance, if you are looking for a shallow CCTV distribution cable and the depth indicated is 5ft (1.5m), it should raise a concern).
- Take a depth reading on the ground, raise the locator approximately 1ft or 0.25m and repeat the depth measurement. The depth should increase by this amount. If not, treat the information with caution.
- Due to distorted fields, a depth reading on congested areas or close to bends or tees may be inaccurate.

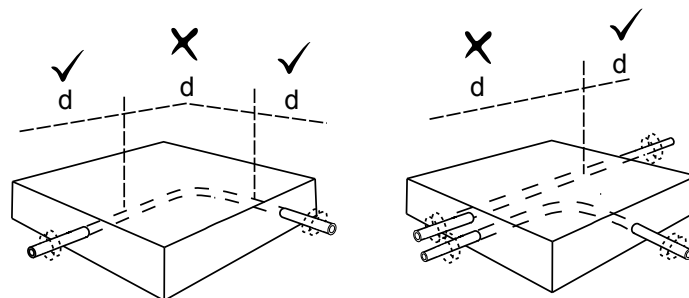

3.10 Sonde-Location Mode

A Sonde is typically used for locating non-metallic pipes or ducts or the camera end of a sewer inspection camera. Low-frequency versions (512Hz/640Hz) can transmit through some metallic pipes such as cast iron pipes which is why they are frequently used with sewer inspection cameras.

The Sonde Location mode is a Peak mode which means that the bar graph and audio will grow when approaching the sonde and at their maximum when over the sonde.

Sonde screen:

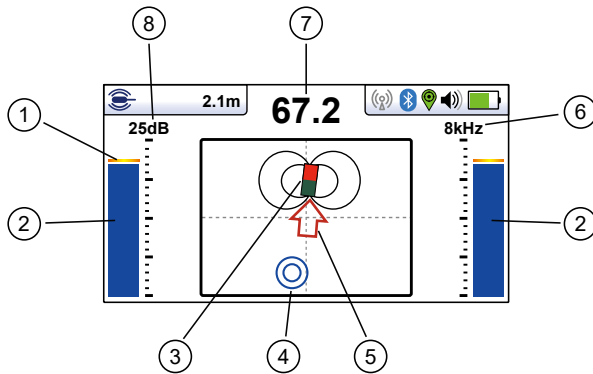

1. Peak signal detector
2. Signal strength bar graph
3. Sonde icon
4. Null point
5. Direction to sonde
6. Frequency selection
7. Numeric signal level (mirrors the bar graph)
8. Gain setting

The Sonde transmitting coil radiates differently than that of a line.

Due to this construction the sonde gives a different “Peak” pattern than when locating a buried utility.

There will be three distinct peaks. A large Peak will be followed by two smaller Peaks on each side of the large one. A Null point will be between each small Peak and the large Peak. The sonde is located under the center of the “Large Peak.”

The vLoc3 receivers detect the two “Null” signals and the position of the main “Large Peak.” It uses this information to provide a reliable and efficient method of sonde location.

The vLoc3 Sonde Screen will display the **Large Peak as a Sonde icon** and the **Null Points as double blue circles**, as shown in the illustration to the right.

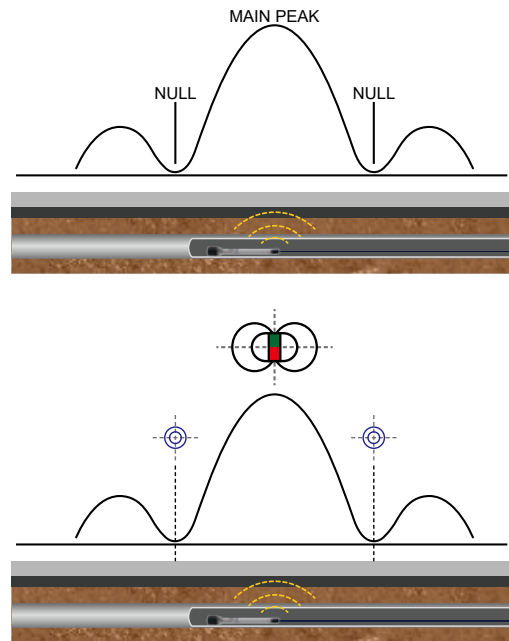

Method

1. Switch on the vLoc3 receiver and use long presses on the Enter key to enter the Sonde screen.
2. Press the “f” key to select the sonde frequency matching the sonde being located.
3. Insert the activated sonde into the pipe. Push the sonde about 10 – 12-feet (3-4m) into the pipe.
4. Hold the locator vertically and stationary with the tip on the ground.
5. When the receiver is within the sondes range a screen similar to the one below will be seen. On the screen, the arrow will be pointing to the sonde. The bar graphs on either side of the screen are identical and indicate the signal strength. Use the + and – keys to alter the receiver gain to keep the signal within the bar graph's limits.

3 Using the vLoc3-5000

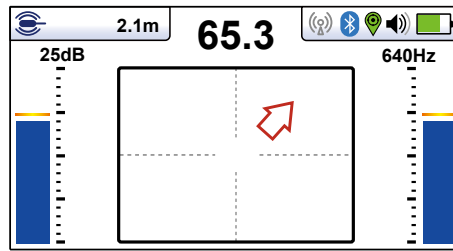

6. If the bar graph is not steady, it will most likely be because the sonde is not within range. In this case, hold the locator at approximately 45 degrees to the ground and rotate the locator around a full 360 degrees around you. Note the strongest signal's direction and walk towards it until the bar graph shows a steady signal. Now revert to step five above.
7. Walk slowly in the direction of the arrow.
8. A double circle will appear on the screen, indicating the position of a null signal. Walk toward it and position it over the crosshairs of the screen. Now rotate the locator so that the arrow is pointing forward.

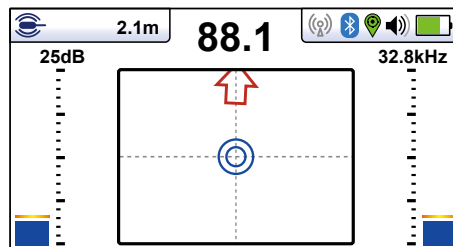

9. Keeping the null indicator on the vertical line walk toward the arrow.
10. A Sonde icon will soon appear. Keeping the locator vertical carry on walking toward the Sonde until it is positioned on the crosshairs. The locator is now directly over the Sonde. The arrow will flip forward and back as the position is crossed.

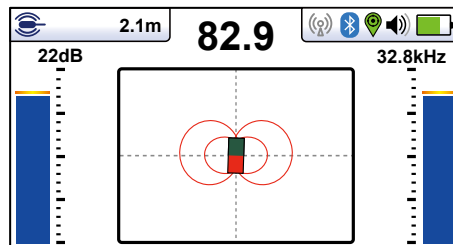

11. Note that it may be necessary to confirm the Sonde position when directly over the Sonde left to right. Do this by moving the locator left to right to identify the strongest signal's position as indicated on the bar graph. At this time the depth of the Sonde will be displayed at the top of the display.
12. Having pinpointed the Sonde position it can now be pushed into a new location and the process repeated. It is advisable to keep the survey intervals too short distances such as six feet (two meters) making locating easier.
13. Pressing the Information key shows the depth measurement and data and data logging capabilities.

3.11 Signal Direction Precision Identification



vLoc3 receivers with the SD option installed will show this SD icon label on the receiver's blade where it meets the yellow upper housing.

Some vLoc3 series receiver locators contain a feature named Signal Direction or SD. This feature verifies that the line being located is the same line that the transmitter is connected to.

When a transmitter is connected to a target line the signal travels along with it and finds the easiest way to travel back, usually via the ground and ground stake. However, the signal will often travel back along with adjacent cables or pipes offering an easier route.

3 Using the vLoc3-5000

As a result multiple signals radiate from cables and pipes in the area making it difficult to identify the target line. These return signals are typically traveling in the opposite direction than the applied signal. The Signal Direction feature identifies which direction the signal is flowing and hence the target line.

To use the signal direction mode:

- Connect the transmitter to the target line using a direct connection only.

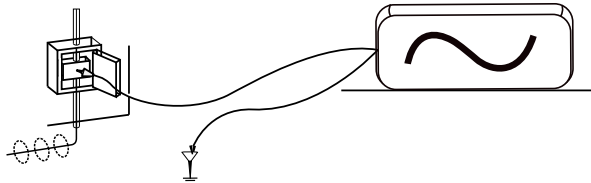

- Turn the transmitter and receiver on and set both to:
 - SD-USA – if in North America or any territory where the power system is 60Hz.
 - SD-EUR – if in Europe or any territory where the power system is 50Hz.
- Locate the cable. The receiver may or may not be flashing the “SD” Forward/Back arrows icon.
- A flashing SD arrow indicates that the unit needs to be synchronized with the transmitter. Even if the arrow is not flashing it is always good practice to synchronize the system at the beginning of a survey to ensure reliable results and maximize the next synchronization point's distance.
- To synchronize the receiver to the transmitter at the beginning of a survey pinpoint the line very close to the transmitter – be sure that it is the correct line. Then, standing facing away from where the transmitter is attached, press the “i” pushbutton. The unit will display the information screen showing the depth of line, signal current, and an “SD” icon positioned over the return pushbutton. Pressing the return pushbutton will synchronize the system and return the unit to the locate screen. The green forward arrow will light and not be flashing indicating the receiver is locked onto the signal. The system is now synchronized.

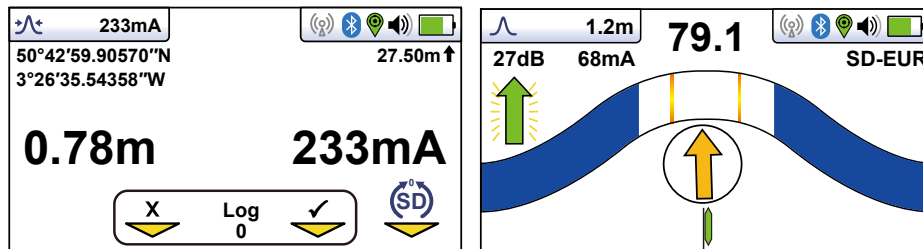

- Proceed to locate, trace, pinpoint as required ensuring at all times the green forward arrow is illuminated. If at any time the red backward arrow illuminates, this indicates that the wrong line is being located.

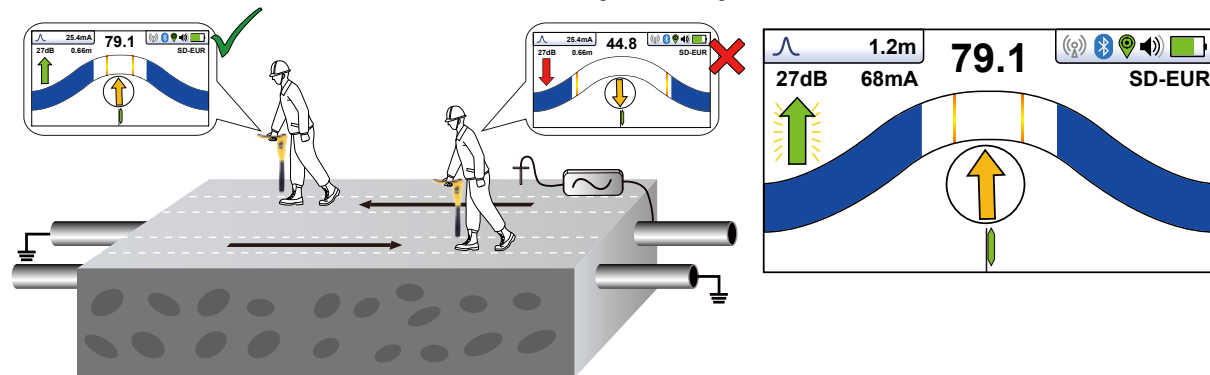

- At some point, you may find that the SD arrow starts to flash – this is indicating that synchronization with the transmitter has deteriorated and a reset is required.
- Re-trace your line back to a point where a solid signal direction is obtained. Precisely pinpoint the line and stand with your back to the direction of the transmitter as you did when you initiated the original sync, and press the “i” pushbutton then the enter/return pushbutton to re-sync with the transmitter signal.

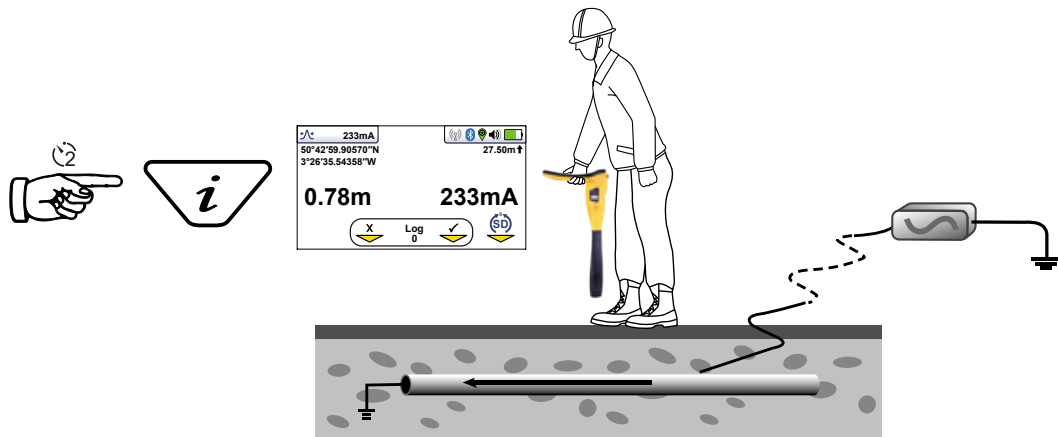

- Continue to locate, pinpoint and trace.



NOTE

If several lines are commonly bonded, the signal direction will carry through to the other lines. This is useful for locating multiple line installations. However, be aware that if a non-target line is commonly bonded to the target line, that line will also appear “in sync” with the target line. When performing a reset, take care to ensure that you have not strayed from the target line.

3.12 Signal Select (SiS)



Signal Select is a feature that helps confirm that the correct line is being located and conveys information relating to the quality of the signal being detected.

Apply the transmitter SiS tone using the Loc3-10SiSTx transmitter. Preferably use the direct connection method as this does not require transmitter-receiver synchronization. See below synchronization reference.

Not all frequencies are available with Signal Select. Frequencies available are identified with “SiS” to ensure the receiver and transmitter are set to the same frequency & mode.

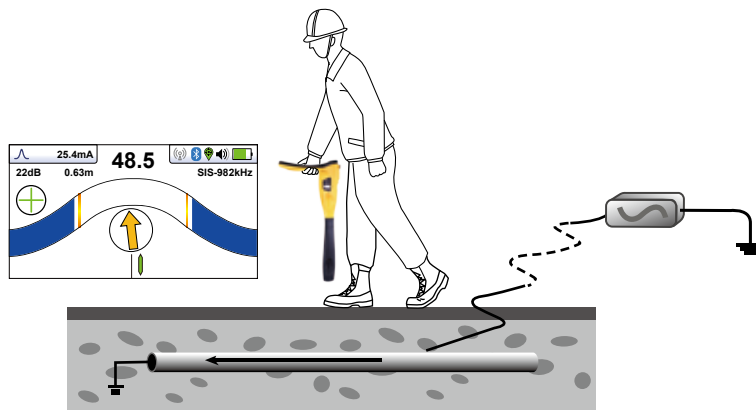

Locate the line as previously described. The “+” “-” indicator and the line direction indicator will show “+” and forward when the correct line is detected.

The direction of the signal in the targeted line is determined by analyzing the demodulated Signal Select signal sign. When the receiver is positioned over a signal that carries an inverted field (i.e., one in which the phase is -180° from the expected), the Guidance Compass points down (backward), as shown below for a line that carries return current.

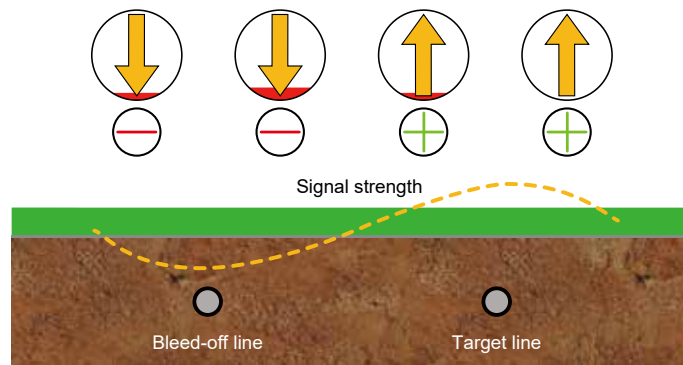

Signal Select Sample Scenario

Distortion Alert



Distortion creates phase anomalies in the signal, which can be detected at the receiver and compared to a phase reference imprinted at the transmitter. This reference is set by Signal Select modulation for every SIS transmitter active frequency. The transmitter must be in direct (conductive) connection mode and a Select Signal mode selected (signal clamps can be used but require synchronization, see the section below). The level of distortion in the field is proportional to the level of the red background in the Guidance Compass.

However, it is not necessarily true that a poor locate results when the Guidance Compass background is predominantly red. The Distortion Alert feature is just that, an alert that a non-ideal magnetic field is detected. In some cases, the conductor that carries the bleed-over current may lay directly on top (in the same duct) of the target conductor. In this case, the predominant current that is detectable at the surface is from the bleed over the line, but the actual centerline estimate is correct.

An example of how the Distortion Alert feature acts as a warning about situations that (using traditional methods) can be seen below. In this case, there is a significant bleed over from the target line to a shallower line, with the current running in the same direction forward in both lines. Since the bleed over line is shallower, its effect diminishes as the receiver is positioned farther to the right or left. Thus the red filling is at a lower level in the Guidance Compass in these areas. The measured distortion approaches a peak about in the same place as the signal strength peak, indicating the presence of another conductor.

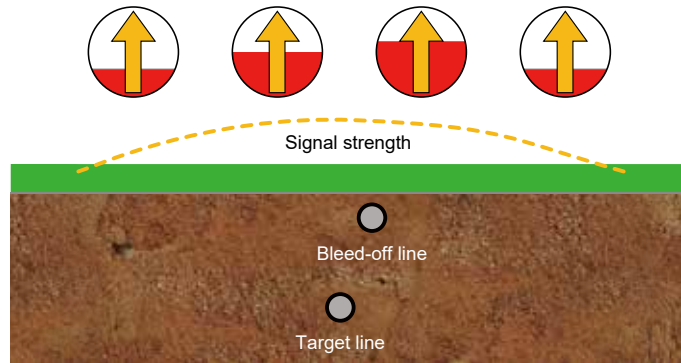

Distortion Alert Sample Scenario

The centerline estimate is not significantly biased in this particular case, though the depth estimate is less accurate.

Synchronizing

If using a direct connection, no synchronization between the transmitter and receiver is necessary. However, if the signal is applied using a signal clamp, they should be synchronized as the clamp can introduce some phase errors (SiS is not available in the Induction mode).

For low frequencies below 8kHz, the SiS clamp should be used. For frequencies 8kHz and above, it is possible to use the standard 4" and 5" signal clamps.

To synchronize the receiver to the transmitter at the beginning of a survey, pinpoint the line very close to the transmitter – be sure that it is the correct line. Then, standing facing away from where the transmitter is attached, press the Information button.

3 Using the vLoc3-5000

The information screen will show a signal select reset icon over the “return” key.



Press the “Return” key to synchronize the equipment. The screen will also revert to the locate screen. Notice the compass arrow will now be pointing forward, and the distortion meter should be empty.



The system is now synchronized.

Note that if the unit is switched off for any reason, the synchronization will automatically revert to the default settings for direct connection.

4. Data Logging

The vLoc3 series receivers have internal storage memory that can be used to store locator data.

The records are user-initiated and stored by the user whenever the “+” button is pressed when in the “Information” screen.

Data can be stored relating to a standard locate or relating to any of the receiver accessories apart from the Remote antenna accessory.

Each time a self-test routine is run the results are automatically recorded in the equipment. Warnings and Alarms are also automatically recorded.

1. To store a record first locate a point of interest.

Hold the vLoc3 stationary over the target and press the “i” pushbutton.

In the depth and current screen press the “+” pushbutton to save the data.

The Log number indicates the number of records stored. To exit the screen without logging the data press the “-” button.

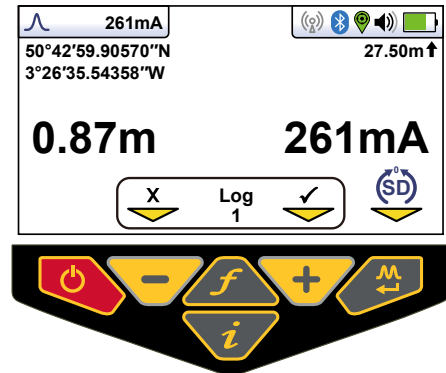

If the GPS function is enabled the GPS coordinates will also be displayed and attached to any saved file. For more information on Data logging and GPS see section 4.2.

2. When the save button is pressed the Log number will increment and the arrow below the check sign will turn green indicating that the data has been stored successfully.

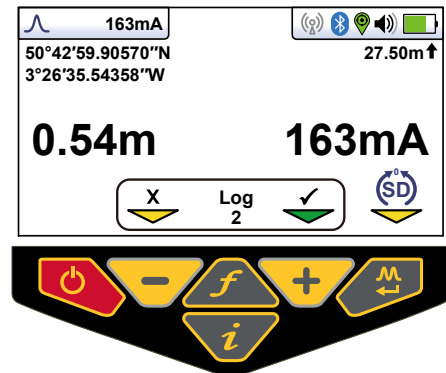

3. The screen will then automatically revert to the locate or accessory screen.

The data logs can also be deleted from the Info screen.

4. From the Info screen, press and hold the “-” key.

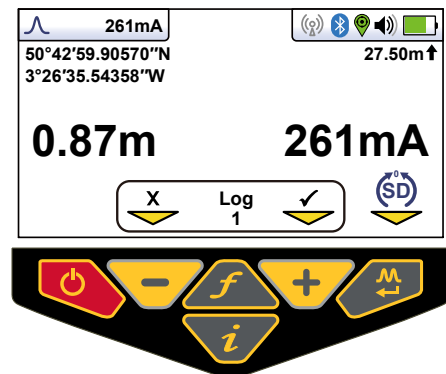

4 Data Logging

5. Press the "+" key to confirm.

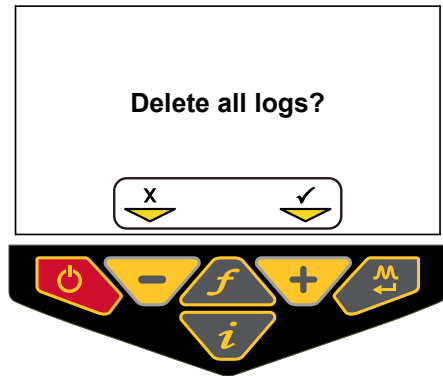

6. Press the "-" key to delete or the "+" key to cancel.

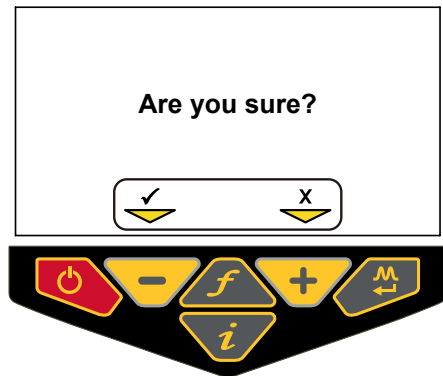

7. After the deletions are complete, the vLoc3 will return to the locate screen.

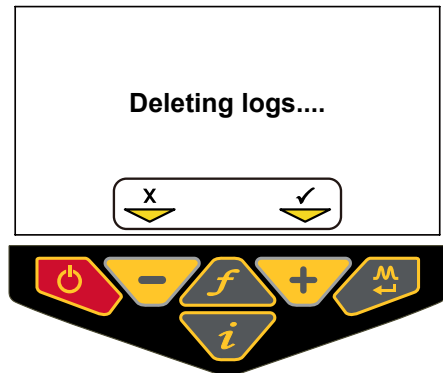

4.1 Bluetooth

As an option the vLoc3 series receivers can be upgraded by the user with a Bluetooth module to communicate with external GPS modules or Dataloggers.



vLoc3 Series Bluetooth Module

4.1.1 Fitting the Bluetooth Module

1. Turn the receiver off and remove the battery pack.
2. With a small cross-head screwdriver remove the two screws of the module cover and remove the cover.



Remove screws



Remove cover

3. The slot on the left is for the Bluetooth module. The slot on the right is not active and for future developments. Carefully slide the Bluetooth module slide into the slot and press with your thumb to secure it in the slot.



Install the Bluetooth module into the left slot

4. Replace the cover and tighten the two retaining screws being careful not to overtighten.
5. Install the receiver battery and switch on the unit. After a few seconds a black Bluetooth icon should appear showing that the module is fitted.
6. If the Bluetooth icon is grey this means the GPS option is not fitted or incorrectly fitted.
7. The Bluetooth module can communicate with external devices that are also Bluetooth enabled. Generally Bluetooth devices fall into two categories of high and low power devices. The vLoc3 Bluetooth module is compatible with low-power devices.

4.2 Pairing with external GPS/Dataloggers

First check that a Bluetooth module is installed in the vLoc3 receiver. A grey color GPS icon on the status bar shows that no Bluetooth module is installed. A Black GPS icon indicates that the Bluetooth module is installed.

Bluetooth pairing with external devices.

1. Switch on the external device.
2. Switch on the vLoc3 series receiver and enter the user setup menu by a long press on the “i” button.
3. Use the “+” and “-” keys to scroll to and select Bluetooth Pairing.
4. Press the Enter key.
5. Press the Enter key to start a Bluetooth search for external devices.
6. A list of available devices will be shown.
7. Scroll to the desired external device and press the Enter key.
8. Double press the “i” button to return to the main screen.

After a few seconds the Bluetooth icon should turn blue indicating the device has paired successfully.

The unit will remember the pairing even after switching off. However the unit can only remember one unit at a time so if the unit is paired with another device the settings will be replaced.

GPS (Global Positioning System)/GNSS (Global Navigation Satellite System)

The vLoc3 series receivers can utilize location data from an external GPS/GNSS. The vLoc3 receiver needs to be paired with an external device (see the previous section on Bluetooth devices).

Once paired with an external device the vLoc3 receiver will await valid GPS data from the external device. The GPS icon will turn green when a valid GPS signal is detected. It can take from a few seconds to a few minutes depending on the device and whether it is doing a “cold” or “hot” start.

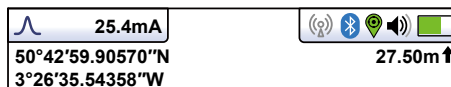

4.3 Transferring Data from the vLoc3 Receiver to a Computer



MyLocator3

One method of transferring data is to use the vLoc3 Series Configurator Tool "**MyLocator3**". This free desktop program can be downloaded from the Vivax-Metrotech website.



VMap

Another method to access the locator data is by using the **VMap App** which will store all the locator's data in the web portal. See our website under "Apps" to learn more.



To view Google kml files, the Google Earth app is needed.
This free app can be found by doing a google search for Google Earth.

4.3.1 MyLocator3

This section describes the user operation of the MyLocator3 PC application.

MyLocator3 is a desktop PC application capable of downloading code and configuring the vLoc3 series of locators.

The first part of this document, Basic Operation describes usage not requiring a USB security dongle. The second part of this manual, Advanced Features describes usage requiring a security dongle.

MyLocator3 is a free downloadable App available at www.vivax-metrotech.com in the Apps section.

Follow the instructions to download and install the application. A "MyLocator3" icon will appear on the computer desktop after the app is installed.

Connect your vLoc3 series receivers to the computer via the mini-USB connector which can be found under the battery cover flap. Launch MyLocator3 by double clicking on the icon.

4.3.2 MyLocator3's Basic Operation

MyLocator3 operation not requiring a USB security dongle.

4.3.2.1 Updates Page

When a locator is first connected to the PC the Updates Page will be displayed. The updates page will show the locator variant type, the locator serial number and the running firmware version in the upper left-hand boxes. The upper right-hand box will show information about the MyLocator3 PC application.

Clicking on the Clock symbol sets the locator time to UTC. To check local and UTC hover over the Icon and the times will be displayed to the right flashing alternately.

Checking the "Auto Load Config" box ensures the locator's configuration setting is automatically uploaded to the MyLocator3 app when the locator is connected.

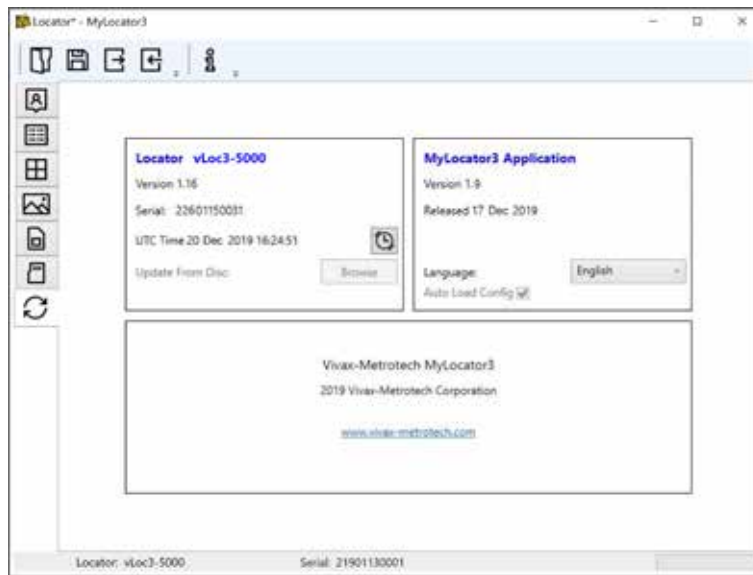

The MyLocator3 Start Page

MyLocator3 can be viewed in several language options. Click on the pull-down menu to select the desired option.

4.3.2.2 Application Update

Every time the MyLocator3 Application is started, its version number is checked against the latest version available on the Vivax-Metrotech server. The user is notified if an update is available as in the below illustration. This feature will only be available if the computer is connected to the internet.

Clicking on the Update Now button will download the latest version from the Vivax-Metrotech server which the user can install.

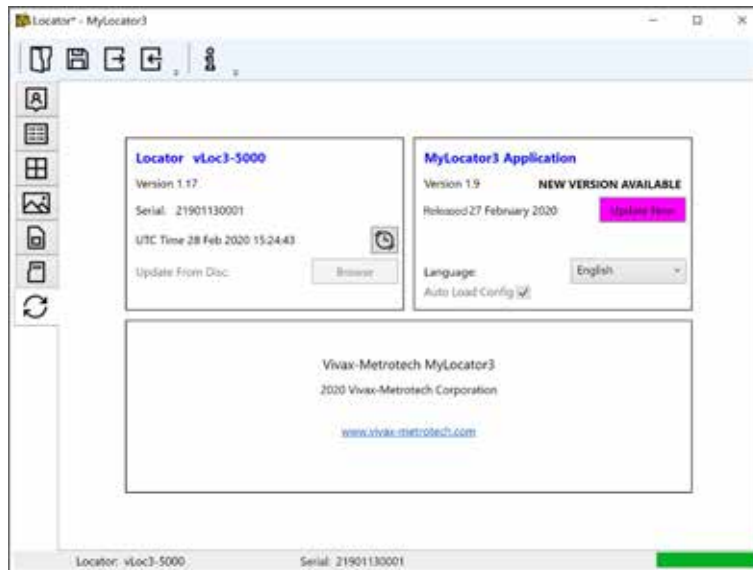

4.3.2.3 Locator Firmware update

Each time a locator is connected to the PC, its firmware version is checked against the latest version available on the Vivax-Metrotech server and the user is notified if an update is available, as shown below. This feature will only be available if the computer is connected to the internet.

Clicking on the Update Now button will fetch the latest version from the server and then download it to the locator.



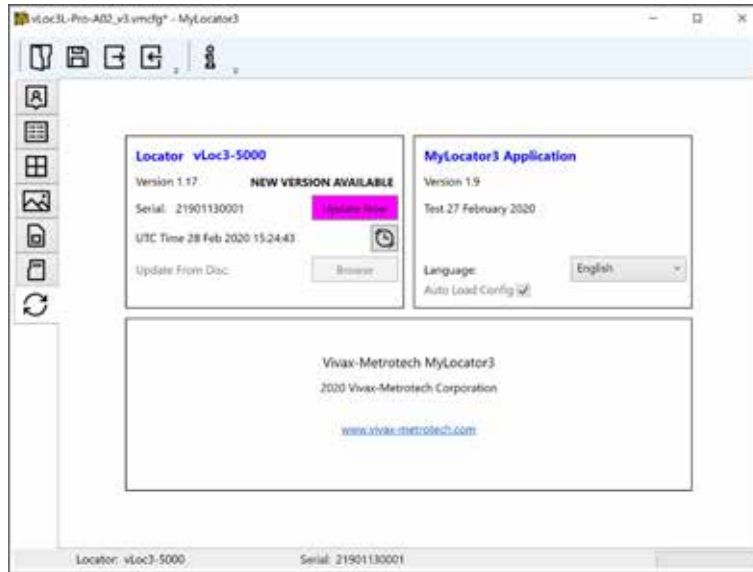







The Update From Disc feature will only be available if a suitable dongle is attached to the PC. This feature allows the user to install older versions of firmware stored on the computer although it is advised that only the latest version of firmware is used.



4.3.3 Toolbar

The vLoc3 series receivers can be configured so that features can be switched on or off. Doing this enables the user to tailor the instrument to meet their application's needs while keeping the user interface uncluttered. The toolbar at the top of the screen enables the user to create configurations.

The application toolbar looks like this:

 New.vmcfg MyLocator3	 Opens an existing configuration file (*.vmcfg).
	 Saves the configuration to a file.
	 Writes the configuration to the connected locator.
	 Reads the configuration from the connected locator.
	 Displays information about MyLocator3.

4.3.4 Data Logging

Clicking on the Data Logging tab will display information about the state of the attached locator's data log contents. The data log contents can be stepped through by using the controls on the right-hand side. The user can upload a selection of logs from the locator to the PC using the upper right-hand side controls. The data in the data log can be configured before exporting. The parameters that can be set are:

- Distance units
- Date format
- Time format, i.e., UTC or local time

Files may be exported and saved locally as .csv, .bin, .kml or .shp files and examined later. The default filename is based on the serial number of the connected locator but can be changed during the saving process.



If it is only required to export a portion of the log (for instance, a survey on a particular day), use the data log scroll facility at the bottom left of the display to scroll through to the start date and time. Note the log number and then scroll to the end date and time and note this log number. Use these numbers to enter the From - To numbers in the display's top right when exporting. Doing so will help to keep the exported data to a manageable size.

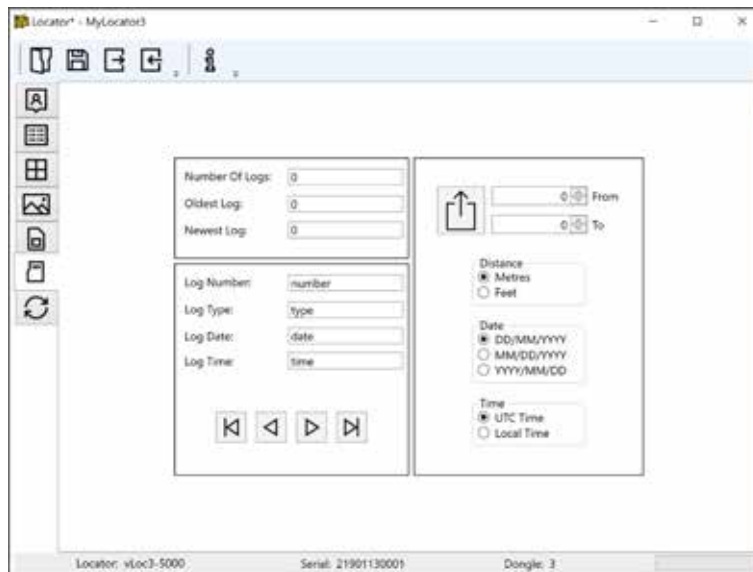

Data Log management screen

Before exporting the data use the **Log Type** dropdown tab to select the type of data required. Options are:

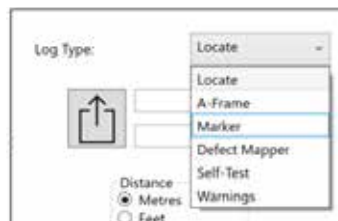

Log type dropdown list

4.3.5 Splash Screen

In this section, an image can be loaded as a splash screen when the locator is turned on. The locator has an LCD screen with a resolution of 480 by 272 pixels. The image loaded into MyLocator3 will be scaled to fit the width of the screen. If the scaled image height is less than the LCD height, then the image is centered vertically, and white bars are used as padding. If the scaled image height is greater than the LCD height, then the image can be re-positioned vertically by clicking and dragging the left mouse button anywhere on the image.

To insert your startup screen, first, click on the “Open” button. Then browse your files to select the picture required as the startup screen. The application is compatible with file formats .jpg, .bmp, .png and .gif.

The startup screen will be displayed in the application.

The Download button can be used to set the splash screen immediately, or the image can be sent to the locator along with the rest of the configuration by pressing the Write Configuration button.

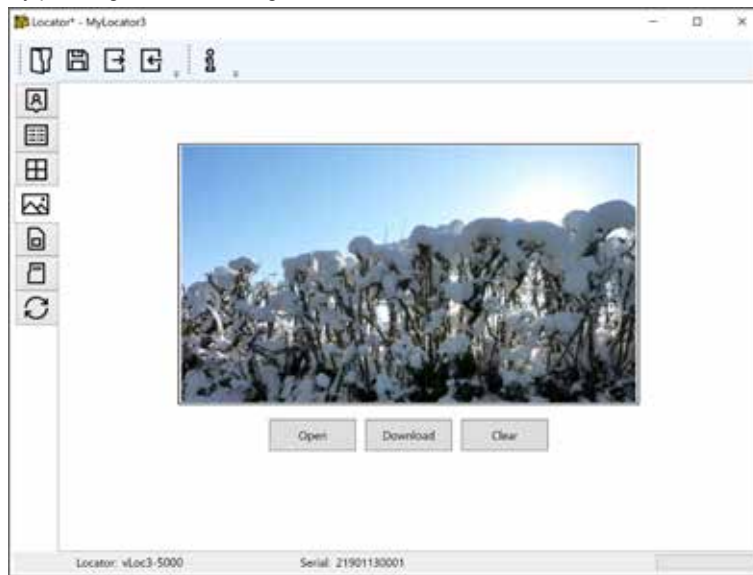

The Splashscreen download area

To remove a startup screen and revert to the default Vivax-Metrotech screen, click on the “Clear” button and download the cleared screen.



The default factory loaded splash Screen

4.3.6 Frequencies Page

The "Frequencies" page allows the user to select which frequencies and modes are available when the locator's F-key is pressed and which frequencies appear on the locator's menu.

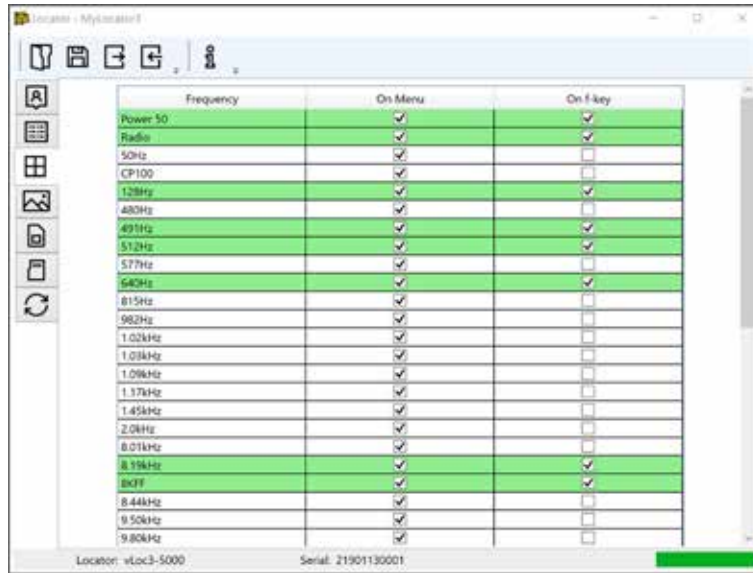

The Frequency page list

4.3.7 Menu Settings

The "Menu Settings" page gives the user control over which menu items appear on the locator and the menu item's initial setting when the locator is first used after configuration.

The menu items with a right-pointing arrow  can be expanded to reveal additional sub-menu items. If the "On-Menu" item is ticked, then the item will appear on the locator menu. The item displayed in the "Setting" column will be the initial locator setting after configuration. If the "Setting" value is not selected, then the locator setting will be unchanged.

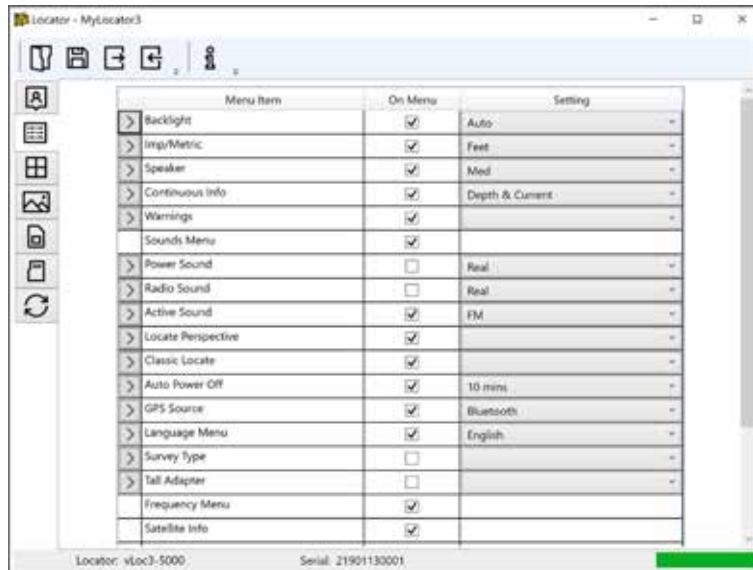

Menu settings

4.3.8 Advanced Features

The Advanced Features are available to those users in possession of a USB security dongle. If a dongle is attached to the PC, its level will be displayed on the MyLocator3 status bar.

Three levels of security come with the dongle. Level one is for the end-user supervisors, level two for Vivax-Metrotech's distributors, repair centers, managers, and level three for Vivax-Metrotech use only.

4.3.8.1 Supervisor Lockouts

This feature is available to anyone with a dongle (contact Vivax-Metrotech to purchase a dongle). When a dongle is connected to your computer via a standard USB socket, the icons for the "Splash Screen" page, "Frequencies" page and the "Menu Settings" page will change color to green. This color indicates the page is unlocked.



Levels of Dongle security

1. End-user supervisors
2. Vivax-Metrotech distributors, repair centers, and managers

The Splash Screen page, Frequencies page, and Menu Settings page can be individually locked by double-clicking on their page tab icon. If a page is locked, a user can only access it with an appropriate security dongle. Doing so will prevent unauthorized users from changing protected locator items. i.e., the "Splash Screen" can be locked to prevent the user from changing it.

The page tab icon will change color from green to amber.

To unlock a tab with the dongle connected, double click on the tab to unlock.

5. Loc3-10SiSTx Transmitter

5.1 Loc3-10SiSTx Transmitter Overview

The Loc3-10SiSTx transmitter is a rugged portable transmitter powered by alkaline “D” cells or Li-ion rechargeable batteries. The following describes the features and uses of the transmitter.



1. Loc3-10SiS Transmitter
2. Ground stake
3. Direct connection lead
4. Mini-USB lead
5. Alkaline battery tray

5.1.1 Display

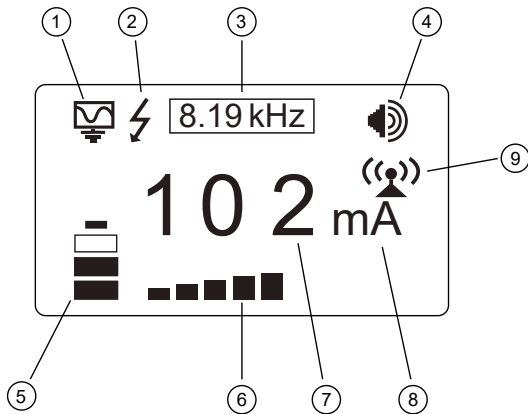

1. Mode indication icon
2. High Voltage Warning*
3. Active frequency
4. Speaker level
5. Battery status
6. Output step bar graph
7. Digital readout (mA, volts, ohms)
8. Units (mA, volts, ohms)
9. Tx-Link Status
Blinking icon = Tx-Link is not paired
Solid icon = Tx-Link is active and linked to the transmitter

*Output Protect Warning

The transmitter checks the line when connected. Output protected against accidental momentary connection to up to 230V AC (RMS), it will display the high voltage warning icon and not allow the transmitter to operate. In addition, the transmitter is protected by a 4A/250V fuse in the event of excessive voltage or voltage spikes on the line.

5.1.2 Pushbuttons

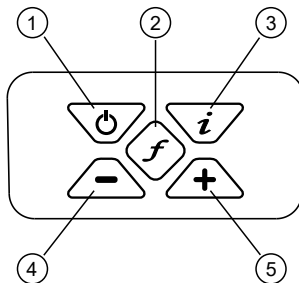

1. On/Off button
2. Frequency selector
3. Information (Volume, Volts, Ohms, Multi-frequencies LCD Contrast, Receiver Link, Frequency menu and About screen)
4. Output decrease/navigate through the menu
5. Output increase/navigate through the menu

5.1.3 Transmitter Information Pushbuttons

Press the “i” button to access the transmitter settings and menu.



Use the “+” and “-” buttons to navigate the settings and menus.



Use the “f” button to make selections. An X will appear for selected items.

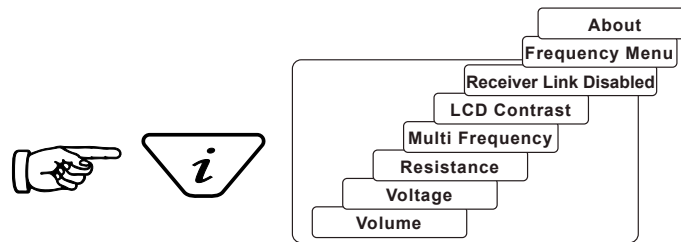

Transmitter Menu Structure

When the “i” pushbutton is pressed the display will show the volume level. Use the + and - pushbuttons to increase, reduce or turn the speaker off. (off-low-medium-high).

Keep pressing the “i” pushbutton, and the display can be toggled to show “voltage,” “resistance,” or other functions as shown in the illustration above. The display indicates mA as the default and volts or ohms when selected.



NOTE: The number of “i” button presses and available sub-menus will vary with the transmitter’s mode.

5.1.4 Transmitter Connections Block

Transmitter Connection Block

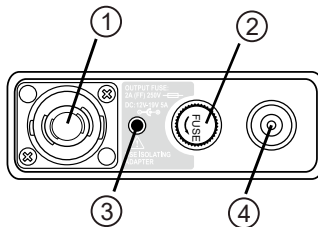

- | | |
|----|--|
| 1. | Output connection, speakON® |
| 2. | Fuse holder - Output protection (2A/250V Fuse) |
| 3. | Speaker |
| 4. | Battery charging & DC input socket |

All the connections made to the transmitter are made at the connection block except for a USB socket which is mounted inside the battery compartment and is used for the transmitter’s software upgrade.

The connection block consists of:

- Output (XLR) socket – for the direct connection lead and clamp.
- Fuse – this protects the transmitter circuitry in the event of the transmitter receiving up to 250V incoming voltage on the output leads, or higher than allowed current.
- A beeper is positioned behind the small hole.
- Transmitter 12V DC power lead used to power the transmitter from a vehicle and if rechargeable batteries are fitted, will charge the transmitter at the same time.

5.2 Transmitter Batteries – Li-ion and Alkaline

The 10-watt transmitter uses 12 x D alkaline cell batteries. An optional Li-ion battery tray is available as an accessory.

On all transmitters the battery status is shown on the transmitter's LCD. The letters "LP" will appear when the battery status reaches only one bar. At this battery level, the max output current and power are limited.

The LED on the charger will show a red light indicating that the charge cycle is in progress. When the batteries are fully charged, the LED will change to green.

Follow the instructions detailed in the General Safety & Care Information section of this document. Dispose of batteries following your company's practice and environmental standards the prevailing laws or recognized best practice. Always dispose of batteries responsibly.



WARNING

Use only Vivax-Metrotech recommended charger.

Do not attempt to replace the rechargeable batteries or remove battery covers.

Return to Vivax-Metrotech or a Vivax-Metrotech approved service center for replacement.

5.2.1 Charging the Li-ion Battery Tray

The rechargeable battery tray can be charged while attached to the transmitter or on its own. The battery condition (status) is displayed on the transmitter's display.

1. Connect the charger to the charging socket on the transmitter's side or directly into the battery tray's charging socket.
2. The LED on the charger will glow red while charging and turn green when fully charged.

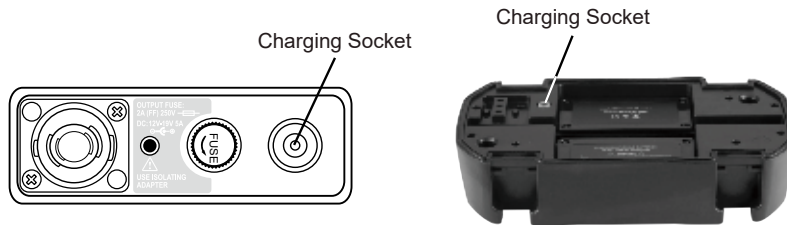

Plug the charger into the charging socket on the side of the transmitter or directly into the battery tray

Battery Charger - is supplied with the optional Li-ion battery tray.



Optional 12-volt DC Power Lead - this 30ft/90m lead can be used to power the transmitter when connected to a target line at high output levels for extended periods. It will not charge the transmitter battery.



WARNING

Only use a charger supplied by Vivax-Metrotech Corp. Using non-approved chargers may result in damage to the equipment or overheating/explosion.



NOTE



The rechargeable tray cannot be charged from a 12V DC source.

Follow instructions detailed in the General Safety & Care Information section of this manual. Only use the battery charger supplied as using an unapproved charger may damage the battery pack and may cause overheating.

5.2.2 Removing and Installing the Battery Tray

These procedures apply to both the Alkaline and Rechargeable battery tray.

Removing the battery tray		
		
1. Reach under the catch and pull to unlock.	2. Lift the catch and repeat for all four catches.	3. Lift the transmitter base from the battery tray.

Installing the battery tray		
		
The battery tray and transmitter base have matching aligning post, contact pins and socket. Aligning the contact pins into their receptacles will assure that the contact pin will mate and not get damaged.	1. Align the aligning post and lower the transmitter base into the battery tray.	2. Press down on the locking catch until it clicks, and locks in place. Rotate the transmitter locking all the latches.

5.3 Transmitter Modes

The transmitter has three transmitting modes, which are selected automatically. They are Direct Connection, Induction and Clamp.



WARNING

Always connect the transmitter to the target line following your company's procedures. These operations should only be performed by authorized personnel. Always make connections before switching on the unit. Turn the transmitter off before disconnecting.

5.3.1 Direct Connection Mode

The **Direct Connection** mode is automatically selected by plugging a connection lead into the output socket. An icon confirming the direct connection mode is shown on the display. The wave in the icon fluctuates when the transmitter is operating. The direct connection lead consists of two colored cables with clips and covers. The red clip must be connected to the conductor being located, the black clip to a suitable ground such as the ground stake provided with the transmitter.

A good connection is indicated by a change in the beep rate from the speaker and the current reading on the display.

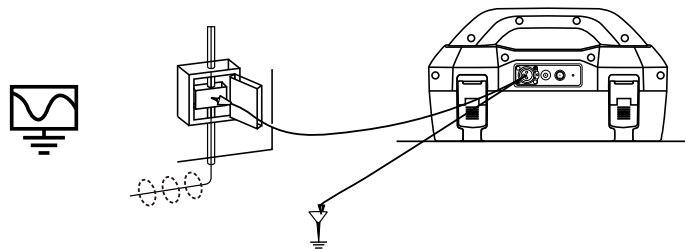

Wherever a direct connection can be safely made without the risk of injury, damage to the customer’s plant, or the transmitter, it is the best way of applying the transmitter’s signal.

The positioning of the ground connection can also influence the degree of coupling experienced. Ground connections generally should not be made to other pipes or cables or above ground metallic structures such as wire fences. In general, the lower the frequency is, the further the signal will travel, and the less signal-coupling will occur. The most common frequencies used for direct connection are between 512Hz/640Hz and 8kHz.

Regulations in many countries require that power output is limited above specific frequencies. The Loc3 series transmitters enable frequencies below 45kHz to be transmitted using as much as 5-watts,10-watts or 25-watt output, depending on your transmitter, but frequencies over 45kHz are restricted to 1-watt. Using direct connection and the higher power at the low frequencies helps significantly in achieving greater location distances. Direct connections should not be made to cables carrying greater than 25V (or as your safety practices allow). The transmitter is protected (250V fuse) from stray currents that may exist on the target line.

5.3.2 Clamp Mode

The transmitter signal clamp is a precise way to apply the locate signal. Clamps are generally used when it is impossible to access the conductor to make a direct connection, but there is access to place the clamp around the cable. Clamps are also used when it is not safe to connect because the target cable is live carrying electricity.

The clamp is a specialized inductive device (sometimes known as a toroid or coupler). All clamps are optimized to work at specific frequencies. In most cases, clamps are designed to be used at frequencies generally between 8kHz and 9.82kHz. The transmitter will only allow the selection of a suitable range of frequencies for your clamp.

Plugging a Vivax-Metrotech clamp into the output socket will place the transmitter into the “Clamp” mode. An icon confirming this is shown on the display and will flash when the transmitter is transmitting.

When using the clamp, no ground connection is needed.

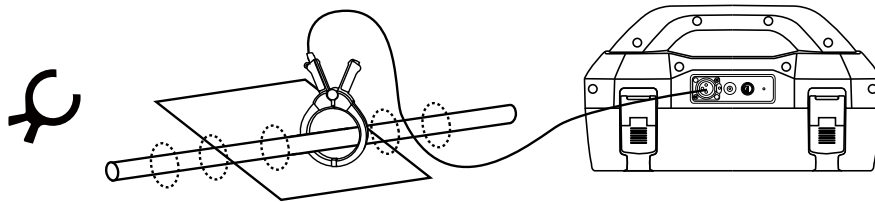

WARNING

When applying the clamp to cables that carry electricity – be sure to follow your company’s safety instructions and procedures. Beware that if applied around a high voltage cable – that cable may induce a current in the clamp, causing it to snap shut or jump quite dramatically – always apply clamps carefully.

5.3.3 Induction Mode

The 5 and 10-watt transmitters use an internal antenna to induce a locating frequency onto the target utility. The Induction mode is automatically selected if no connection accessories are plugged into The 5 and 10-watt transmitters use an internal antenna to induce a locating frequency onto the target utility. The Induction mode is automatically selected if no connection accessories are plugged into the “output socket.” An icon indicating the “Induction” mode will show on the display. The icon flashes when the transmitter is transmitting. In order to generate successful induction, the transmitter should be positioned over and with the handle in line with the target line.

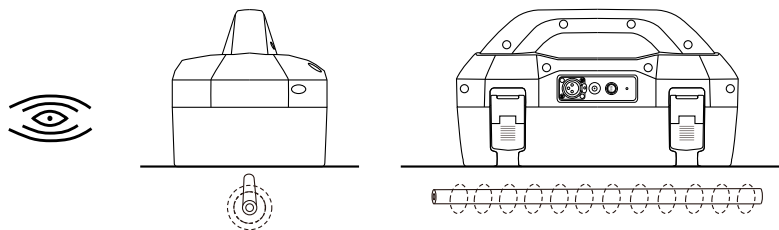

“Induction” mode is generally used when no access is available to make a direct connection or a clamp connection. When using induction, likely, the signal being induced onto the target line will also be induced onto other lines in the area and onto above-ground features such as wire fences. This can influence the accuracy of the location, depth, and current measurements. “Induction” mode is also the least efficient way of applying the transmitting signal to the target line. The distance located with the “Induction” mode is generally much less than that achieved with a direct connection or clamp connection. The “Induction” mode is only available from 8kHz and above.

Induction frequencies are available based on the user selection. See section 5.4.2 for information relating to the “Most Used Frequencies (Frequency Selection) Feature” to add and remove frequencies from the favorite frequencies list.



NOTE
For accurate location and depth measurement, the locator receiver should be used no closer than 66ft (20m) from the transmitter.

5.4 Transmitter Frequencies

The Loc3 series transmitters are supplied with a predefined set of transmitting frequencies. The factory will present the most used frequencies. Additional frequencies are available to be selected in the frequencies list.

5.4.1 Frequencies and Maximum Power Output

Frequencies power outputs	Loc3-10SiSTx
Direct connection 10-watt:	98Hz-45kHz
Direct connection 5-watt:	-
Direct connection 1-watt:	>45kHz- 200kHz

Clamp Connection: Available frequencies between 8.19 kHz and 200 kHz

Induction Frequency: Multiple induction frequencies between 8.19kHz and 200kHz

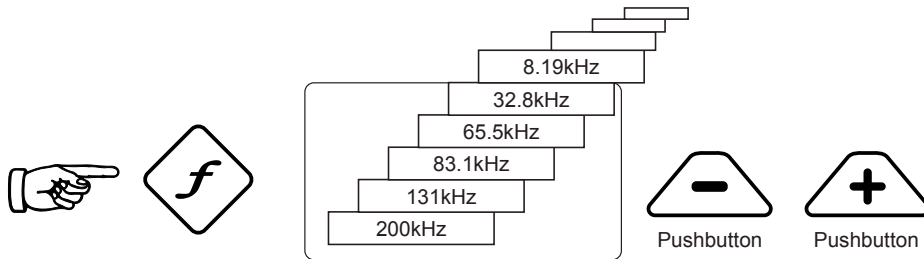

As with most manufacturers, signal clamps are tuned to specific frequencies and **will not** work over the complete range of frequencies.

Frequencies are selected by pressing the “f” pushbutton, which toggles through the frequencies available in the current mode's available frequencies. The frequency is automatically selected if you don't toggle past it within two seconds.

NOTE
The output current is shown in large characters on the display. To increase or reduce the current output, press “+” or “-.” The vertical bar graph at the bottom of the display indicates which of the seven current output steps is being used. If the transmitter can supply the requested current, the bar will turn black. If the bar does not turn black, improving the ground connections or wetting the ground where the earth stake is positioned may help. However, it may not achieve the current setting requested because the line's impedance is too high for this setting. If this happens, it is best to select a lower setting with a black bar, ensuring a stable output.
The impedance of the target line will limit the current being transmitted; therefore, it is not unusual to increase the output level but see no increase in the currently displayed. This is not a fault with the transmitter.



The transmitter will always revert to first level output when switched on as a power-saving feature. In most circumstances, this output level is sufficient. Increasing the output power unnecessarily will reduce battery life. All other settings remain the same as the last setting used.

5.4.2 Most Used Frequencies (Frequency Selection) Feature

This feature allows the operator to choose the most used frequencies from a list of frequencies. Once these frequencies are selected in the main menu, the user can scroll through them by pressing the “f” pushbutton. The user can add or remove frequencies from the above list by following the below procedure. The maximum number of frequencies that can be activated in the most used frequencies list is 12.

The advantage of this feature is the user can work with only their preferred frequencies rather than having a more extensive list of frequencies to scroll through.

Enter the Frequency Menu:

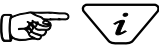
- 
 Press the “i” pushbutton four to six times (based on the mode that the transmitter is in) until reaching the “Frequency menu” sub-menu.

In Direct Connection mode

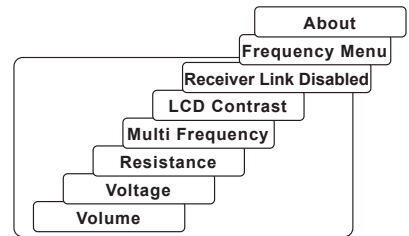

5 and 10-Watt Transmitters

InSD / SiS Mode

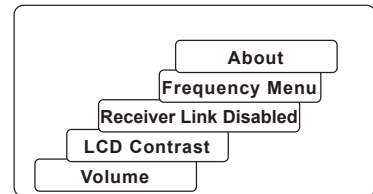

5 and 10-Watt Transmitters

In Clamp Mode

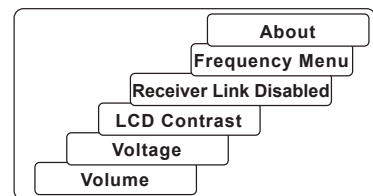

5 and 10-Watt Transmitters

- The screen will show a list of frequencies available, with the central one in a box.

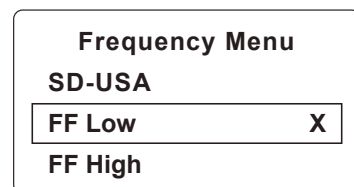

5 and 10-Watt Transmitters

- You can scroll up or down through the available frequencies by pressing the “+” or “-” pushbuttons.

5 Loc3-10SiSTx Transmitter

- Once the wanted frequency is inside the box, press the “f” pushbutton to select or deselect the frequency. An “x” will appear in the box for a selected frequency.

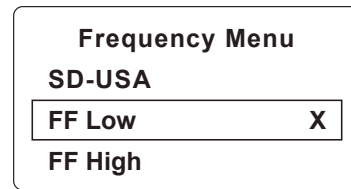

5 and 10-Watt Transmitters

- After selecting the frequencies, press the “i” pushbutton again to exit the “Frequency Menu” and return to the main display.
- A frequency in the chosen list of frequencies can be selected from the screen by pressing the “f” pushbutton until the wanted frequency is displayed at the top of the main screen.

5.4.3 Multi-Frequency Mode for Direct Connection

This feature can be used to energize two or three frequencies simultaneously on the target line. This is especially helpful when the user is unsure which frequency is best to apply to the target line.



NOTE

- When using the multi-frequency mode, total power will be split between the activated frequencies.
- The multi-frequency mode is not available in Fault Find, SD and SiS modes.
- The frequencies have to be available in the main menu.

Enter the Multi-frequency Setup menu:

- Press the “i” pushbutton seven times to get to the “Multi-Frequency” screen and press the “f” pushbutton to activate the multi-frequency mode. An “x” symbol will appear, indicating that the multi-frequency mode is activated. Press the “f” pushbutton again to go to the “Multi-Frequency. Setup” screen to choose the frequencies.

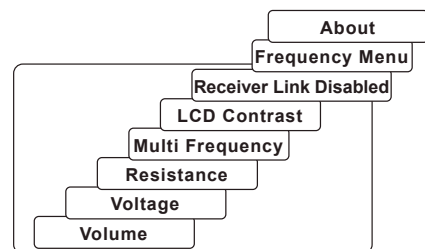

- Use the “+” and “-” pushbuttons to scroll through the available frequencies and add the desired frequency in the first box.

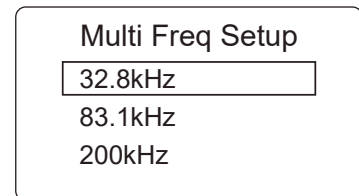

- Press the “f” pushbutton to move the box down and the “+” and “-” pushbuttons to select the second frequency.

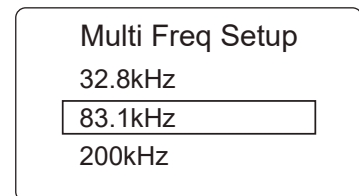

- Repeat step three to select the third frequency if needed.

- Press the “i” pushbutton to return to the main display. On the main display, “Multi” will appear, indicating the multi-frequency mode is active.

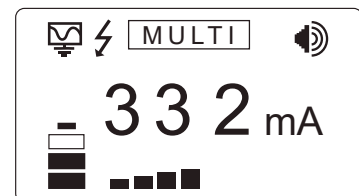

- The frequencies selected for multi-frequency mode will be saved until changes are made, even when the multi-frequency mode is deactivated.

5.5 Transmitter Link (TX-Link)

Currently the Tx-Link feature is **only available in the 5-watt and 10-watt transmitters.**

The Loc3 series transmitters can be remotely operated from the receiver. This option requires the Transmitter (radio) Link to be installed in both the vLoc3 series receiver and the Loc3 series transmitter.

Tx-Link is a factory fit option that must be purchased at the time of ordering. The radio link range depends on having a clear “line of sight” between Rx and Tx but is typically around 300m (984ft).

The Tx-Link feature is shown as RECEIVER LINK in the menu.

Linking a transmitter to a receiver:

1. Press the “i” button repeatedly to scroll through the options until the “RECEIVER LINK DISABLED” option is displayed.
2. Press the “+” key to enter the Receiver Link menu.
Press the “+” or “-” key to highlight the “ENABLE” option, then press the “F” key to start the process. The display will show the message “WAIT” until the setup is complete.
3. An ID number-will now be displayed at the bottom of the screen for identification purposes.
4. The transmitter is now waiting to connect to a receiver.
Either press the “l” button or use the “+” and “-” keys to highlight “BACK” then the “F” key to exit back to the main screen.

When on the main screen, a “beacon” icon will be displayed on the right-hand side. When the icon is flashing, the transmitter is waiting to connect to a receiver. The flashing will stop when successfully connected to the receiver. If no icon is visible, this indicates that the Receiver Radio Link has not been activated.

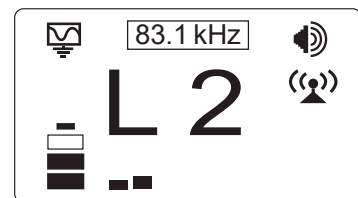
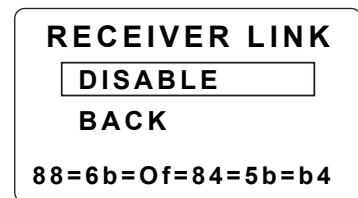
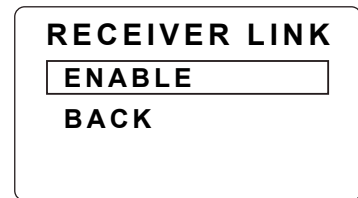

5 Loc3-10SiSTx Transmitter

- While the icon on the transmitter is flashing, indicating that it is waiting to connect to a receiver, switch on the vLoc3 series receiver and enter the user menu by pressing and holding the information button. Scroll down the menu options until Transmitter Link is highlighted. Note that the transmitter and receiver sides of the radio links can be switched on in any order.

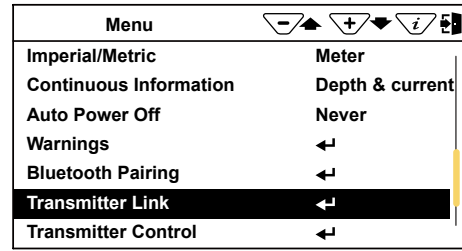

- Select the "Transmitter Link." Check that the radio module is enabled. If not, press the return button to enable the Transmitter Link. After a short scan, the available devices will be displayed. Highlight the one to be selected and press the return button. Press the information button to return to the main menu.

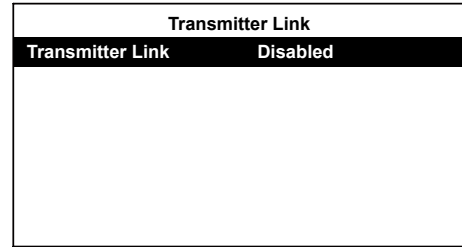

- The "Beacon" icon on the transmitter should not be flashing anymore at this point. A solid icon indicates that the link has been established.

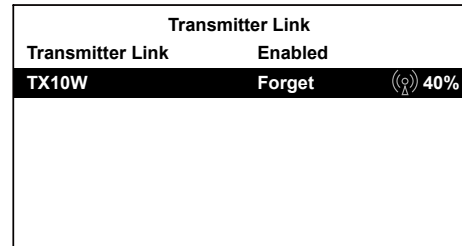

- From the main menu, select the "Transmitter Control" option. (that will become visible when the two devices are linked)
A screen similar to the below should be seen:

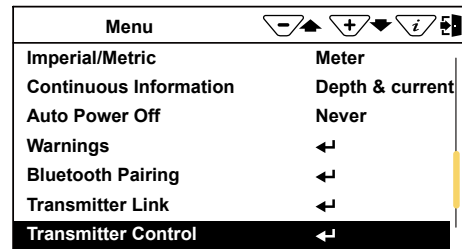

- From this screen, if the link status shows "Connected," it is possible to:
- Alter the output level of the transmitter using the "+" and "-" buttons.
 - Alter the transmit frequency using the "f" button.

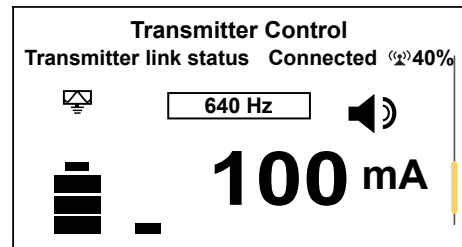

Also shown is the:

- Radio link signal strength, in this case, 40%.
- Output mode, in this case, direct connection.
- Output current, in this case, 100mA.
- Beeper volume setting, in this case, level 2.
- Transmitter battery level.

Use the Information button to navigate/exit back to the locate screen. When in the Locate screen, the status of the Link is displayed in the Status bar.



The various indications of the status are listed below:



No radio module or it is disabled (Always disable in the User Menu when not in use)



No link and no signal



No link and poor signal



No link but good signal



Is linked to the transmitter, but the signal is poor



Is linked to the transmitter with a good signal

TIP



While the Transmitter and Receiver are linked, changing the Receiver Frequency will automatically result in a similar change to the Transmitter frequency, so there is no need to re-enter the menu screen to change the Transmitter frequency remotely. The Frequency indicator will flash when resetting or if an invalid frequency is requested.

If the Tx/Rx Radio link is not being used, make sure the receiver's link is set to "Disabled" on both RX and TX. The radio link will continue to search for the transmitter or receiver that may interfere with the Bluetooth operation. Also, disabling when not in use will conserve battery charge.

6. Using SiS Mode Accessories

The SiS Clamp and SiS Remote Antenna are two accessories that use the SiS mode.

6.1 Using the SiS (Signal Select™) Clamp



The **Signal Select Clamp** is a precise way to apply the locating signal if direct connection is not possible. Signal Select is a special modulation placed on the targeted utility line, to support positive line identification. This feature is available only on the following frequencies SIS-491 Hz, SIS-982 Hz, SIS-8.44 kHz, and SIS-9.82 kHz.



4"/100mm Clamp is a general-purpose clamp that is used for most applications. This clamp can use SIS at frequencies of SIS 8.44 kHz and SiS 9.82 kHz.



5"/127mm Clamp is a general-purpose clamp that is used for most applications. Its unique size clamps around 4"/100mm conduits and ducts. This clamp can use SIS at frequencies of SiS 8.44 kHz and SiS 9.82 kHz.

Signal Select Clamp Mode

Plugging the Signal Select Clamp supplied by Vivax-Metrotech into the output socket will place the transmitter in "Signal Select Clamp" mode. An icon confirming this is displayed on the display. The icon flashes when the transmitter is transmitting. When using the clamp, no ground connection is needed.

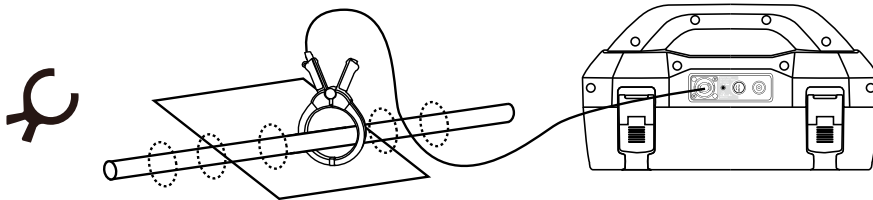

The Signal Select Clamp is a precise way to apply the locating signal if direct connection is not possible. Signal Select is a special modulation placed on the targeted utility line, to support positive line identification. This feature is available only on the following frequencies SIS-491 Hz, SIS-982 Hz, SIS-8.44 kHz, and SIS-9.82 kHz.

Operational Mode

The transmitter can be coupled to the cable inductively with a signal clamp. Since the signal generated from the clamp is directional, clamp orientation is important and must be connected in such a way that imprinted arrow on the clamp points to the cable end.



It is a good idea to synchronize the receiver with the transmitter at the beginning of a survey, pinpoint the line very close to the transmitter – be sure that it is the correct line. Then, standing facing away from where the transmitter is attached, undertake the reset procedure as outlined above in the section 3.12 “Synchronizing”.

Used in conjunction with the vLoc3-5000 receiver, the Signal Select feature becomes a powerful tool in aiding accurate cable identification. At the receiver, a positive (+) icon appears on the operational interface if the operator correctly identifies and traces the line.

A negative (-) icon appears on the operational interface if the operator finds a parallel line or a return current instead of the desired line. Tracing along a line will provide a constant indication of the same polarity.

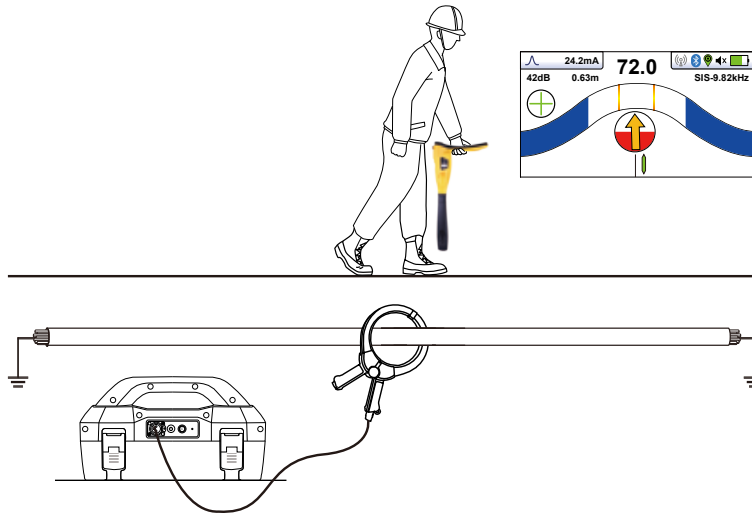

NOTE

It is also possible to apply an 8.44kHz SIS signal using the 4 or 5” (100mm or 125mm) standard clamp. When using clamps it is recommended that a SIS reset is performed at a point that is known to be the target cable.

6.2 Using the vLoc3-5000 SiS Remote Antenna

The remote stethoscope antenna can be used to help trace a particular cable on a cable tray or where cables are bunched together.



Signal Select Antenna Mode

Plugging the Signal Select Remote Antenna supplied by Vivax-Metrotech into the output socket will place the transmitter in “Signal Select Antenna” mode. An icon confirming this is displayed on the display. The icon flashes when the transmitter is transmitting.

Using the Remote Antenna

Methods:

1. Connect a signal to the cable to be identified. The remote stethoscope functions has an operational frequency range of 512Hz up to 200 kHz, but low frequencies should be a preference in this application as they are less likely to leak or bleed over to other cables.
2. When cables are earth bonded together and the cross bonds cannot be removed, the best method of signal application is to use the signal clamp.

6 Using SiS Mode Accessories

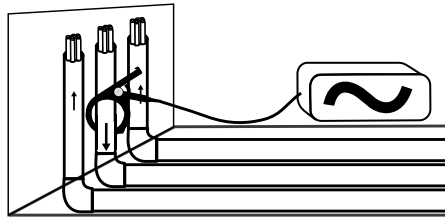

- When using the signal clamp, it is best if both ends of the target cable are grounded. Applying the clamp below the ground point will prevent the signal finding the return path through the ground, so this is not advised.

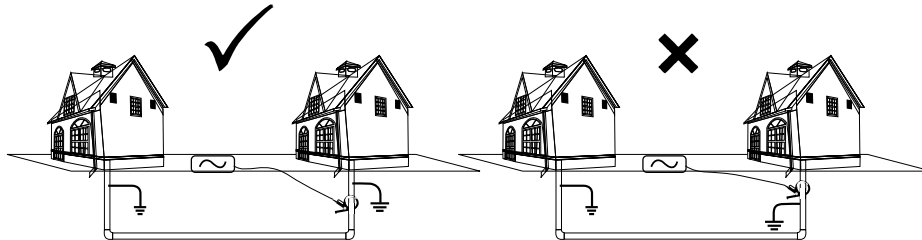

- If it is **not** possible to use a transmitter signal clamp, and you have confirmation that the cable is out of service, use a direct connection lead to make an electrical connection to the cable. Removing any cross bonding between cables prevents the signal travelling along commonly bonded cables.

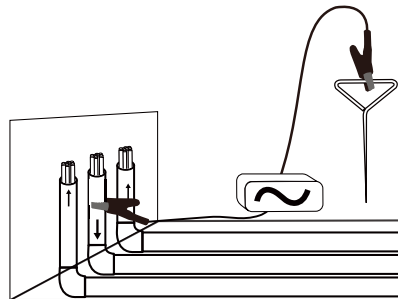

- It is best not to use Induction method as the signal will appear on all cables in the area of the transmitter.
- Connect the remote stethoscope antenna to the accessory input of the receiver. The correct settings and user interface will be automatically selected.

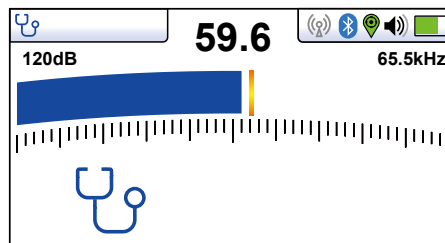

- Ensure the frequency selected on the vLoc3-5000 is the same as selected on the transmitter.
- Place the stethoscope on each of the suspected target cables, if possible part each one from the bunch before each test, with the flats of the antenna in line with the route of the cable.

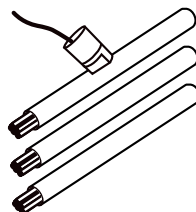

- Note the signal reading of each cable. The one with the largest reading is likely to be the target cable.
- If necessary, adjust the sensitivity of the vLoc3-5000 so that the signal is within the operating section of the bar graph.



WARNING

The remote stethoscope antenna is a useful tool to help trace cables. However, it should not be used as positive identification before an unused cable is cut. Always follow company procedures when cutting disused or isolated cables.



TIP

The remote stethoscope antenna can be used to help trace disused and isolated cables. This process can be further enhanced if the cable is isolated and is of a twisted cable construction.

Method:

- Connect the transmitter to two of the cores of the cable. At the far end, short together these two conductors making a loop.
- Set the transmitter to a low frequency such as 640Hz and set the output to maximum.

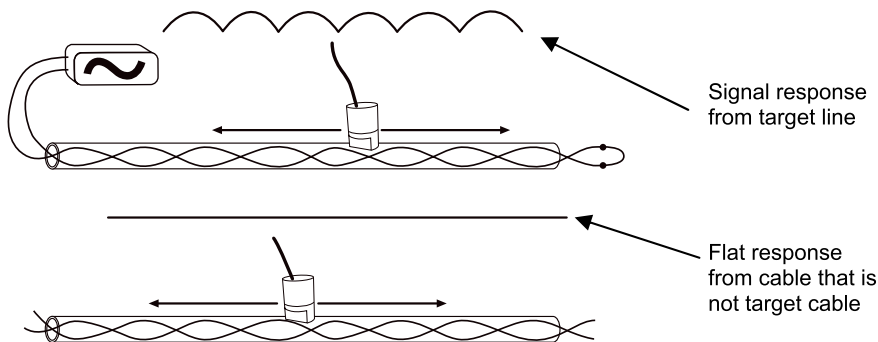

- At the point of interest, if possible part the suspected cable from the bunch then run the remote stethoscope antenna along the suspected target cable keeping the flat portions of the antenna in line with the cable. If the correct cable is being assessed the signal will increase and decrease in sympathy with the twist of the two conductors within the cable.
- If the signal is a steady level and does not rise and fall, this is probably not the target cable.



WARNING

The remote stethoscope antenna is a useful tool to help trace cables. However, it should not be used as positive identification before an unused cable is cut. Always follow company procedures when cutting disused or isolated cables.

6.3 Using the SiS Mode with the Remote Antenna

The use of a Remote Antenna to help identify a cable can be further enhanced with the use of a Signal Select Signal.



WARNING

The remote stethoscope antenna is a useful tool to help trace cables. However, it should NOT be used as positive identification before an unused cable is cut. Always follow company procedures when cutting disused or isolated cables.



6 Using SiS Mode Accessories

Method:

1. Apply the signal using the direct connection method. Remember to isolate the cable beforehand as below. It is also preferable to use the ground stake as an independent ground. Using the station ground may result in multiple signals as the signal will return along commonly bonded cables.

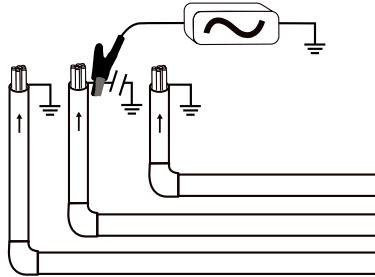

2. Select an SIS signal from the transmitter (there are many available but lower frequencies will create less bleed off to other lines, 491Hz is a good frequency to start with).
3. Connect the remote antenna accessory to the locator and place it on the red lead of the transmitter with the arrow on the remote antenna pointing away from the transmitter. Select the frequency using the "f" button so that it matches the selection on the transmitter. The screen should look similar to the below picture.

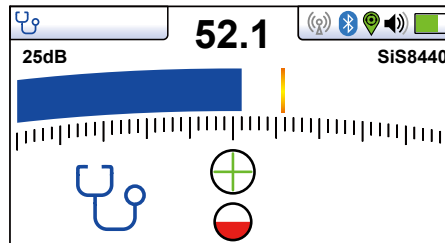

4. If necessary, adjust the sensitivity so that the bar graph is on scale. Note that the front half of the circle is red indicating slight signal distortion, and the polarity sign is "+". This indicates that the signal is flowing forwards.
5. If the "-" polarity is indicated as below, it will be necessary to perform an SIS reset before proceeding.

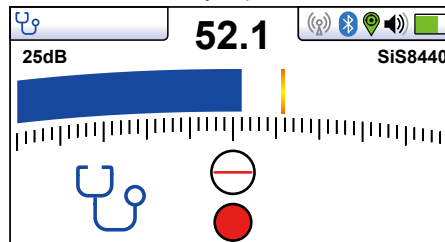

6. However, if in doubt always perform the reset to be sure the antenna and receiver are synchronised.

Performing a remote antenna SIS reset

As previously described, connect the transmitter to the service to be identified, place the antenna on the red cable as previously described. Press the "i" button. The screen will change to something similar to the below.

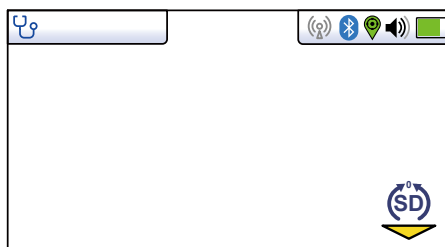

Now press the "Return" key. The screen should now show something similar to the below with the "+" icon showing and little or no red shown in the distortion indicator.

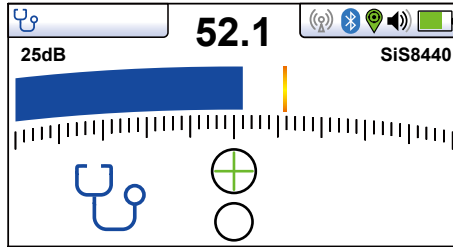

The system is now ready to identify the cable at the location of interest.

Identifying a cable

Having confirmed the antenna is synchronized with the receiver, proceed to the location the cable is to be identified. Place the antenna on each of the suspected cable in turn ensuring the correct orientation with the flats in line with the cable and the arrow on the antenna pointing away from the transmitter.



Note the signal strength on each cable and also which polarity is indicated. The target cable will have the strongest signal and will have a "+" polarity.

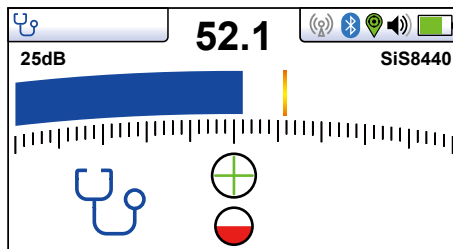

Enhancing the loopback method of cable identification with the aid of the SIS signal

As described before, a more reliable method of loop backing the signal on the cable is possible if the cable is out of service. This method can be further enhanced with the aid of the SIS signal.

Method:

Set up the transmitter as below, with the far end connected together and with the transmitter connected across a twisted pair of cable. Set the transmitter to a SIS frequency such as SIS 491Hz perform an SIS reset as described above.

At the location of interest, hold the antenna on each of the cables in turn. Run the antenna along the cable keeping the arrow on the antenna pointing forwards. On the incorrect cable the signal level will be small and steady. On the correct target cable the signal will rise and fall in sympathy with the twist in the cable. Also, if on the target cable, at each peak the polarity indicator will also change in sympathy from "+" to "-".

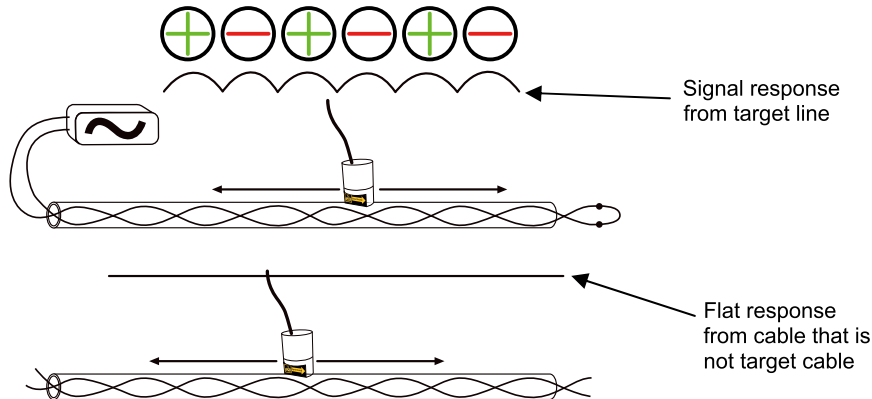

6 Using SiS Mode Accessories

Further confirmation can be achieved by the following:

- Run the antenna along the cable with the flats in line with the cable, stopping at a positive (+) peak signal.
- Rotate the antenna around the cable keeping the antenna at the same point along the cable.
- If on the correct cable, when directly on the opposite side of the cable the signal will again peak but the polarity indicator will show “-”.

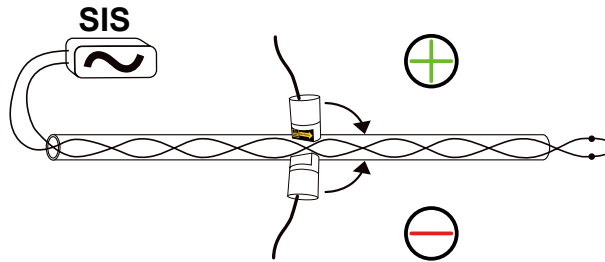

7. Accessories & Options

7.1 Transmitter Signal Clamps



Clamps are accessories used to apply the transmitter signal to an insulated line, removing the need to connect the transmitter signal directly to a conductor or cable sheath.

Clamps are available in 2-inch (50mm), 4-inch (100mm) and 5-inch sizes. An 18-inch (45cm) flexible version is also available.

7.2 A-frame Fault Locator



The A-frame accessory is used to detect ground faults on pipes and cables. In the case of pipes, the faults consist of coating defects. In cables, faults are usually caused by insulation damage allowing the metallic sheath (or internal conductor) to contact the earth.

7.3 vLoc3-MLA (Marker Locator Adapter)





The vLoc3-MLA (Marker Locator Adapter) is designed for easy, fast, and accurate location of buried EMS markers. Once located, the MLA will give the depth of cover to the buried marker with the touch of a button.

The MLA attaches to the bottom of vLoc3-Pro, vLoc3-9800, and vLoc3-5000 receivers. When attached and plugged into the receivers, two marker related operating modes are enabled.

Visit us at www.vxmt.com to see the full range of receiver and transmitter accessories and available options.

8. Glossary

Active Locate	A locate where a transmitter is used to apply a signal to a buried pipe or cable, the position of which is then located by a receiver tuned to the same frequency.
Active Signal	A signal applied by the locator transmitter to a buried line. Typical this is a very precise frequency.
Attenuation	The reduction of an electromagnetic signal from a pipe or cable.
Clamp (or Coupler)	An accessory used to apply the transmitter signal to an insulated line, removing the need to connect the transmitter signal directly to a conductor or cable sheath.
Compass	Line direction indicator although visually like a compass, this is the only relation to a compass.
Coupling	The act of signals transferring to lines to which they were not originally applied. Coupling can be "direct" where the target line has an electrical connection to another line, or "induced" where the signal radiates from the target line to another line or lines.
Display	The information visually available on the dot matrix display.
Line	A generic term for any buried pipe or cable.
Null	A minimum response to a buried line. 
Passive Locate	A locate where the receiver searches for a wide range of signals that radiate from buried pipes or cables. These signals come from a variety of sources in the environment and couple to the buried (& overhead) lines. Typical examples 50/60 Hz and LF/VLF radio.
Passive signals	A wide range of signals that radiate from buried pipes or cables. These signals come from a variety of sources in the environment and couple to the buried (& overhead) lines. Typical examples 50/60 Hz and LF/VLF radio.
Peak	A maximum response to a buried line. 
Pinpoint	Using a receiver to identify the exact position of a buried line.
Response	The indication that the receiver gives which is caused by the signals it is receiving. This can be visual, audio or both. Typically, it is displayed on the locators dot matrix display and audibly from a loudspeaker in the receiver housing.
Search (sweep)	This describes the act of looking for a buried line within a given area.
Sonde	A small transmitting coil which may be built into a product such as a sewer camera or packaged as a small self contained battery powered transmitter. A receiver tuned to the same frequency can locate the position of the Sonde and hence whatever it is attached to or in. Frequently used for locating sewer cameras, and the non metallic pipes.
Target Line	The buried pipe or cable to be located.
Trace	Using a locator to following the path of a buried line.

.....
 Illustrations used in this manual's preparation will inevitably show some resemblance to similar illustrations from other manufacturers. These manufacturers have permitted the use of their graphics. This statement is intended to attribute such credit.

The Bluetooth® word mark and logos are registered trademarks owned by the Bluetooth SIG, Inc.
 iOS is a trademark of Cisco Systems, Inc., registered in the U.S.
 Android, Google and Google Maps are registered trademarks of Google LLC.

Disclaimer: Product and accessory specification and availability information are subject to change without prior notice.

