



vLoc3-Cam User Handbook (English Edition)

Version 1.5

P/N:4.04.000133



General Safety & Care Information

Who Can Use This Equipment

- This equipment must only be used by people suitably trained in the use of pipe and cable locators.

Work-site Safety

- Use your company's, or other applicable safety codes and rules when using this equipment.
- Unless having the required authorization, license and appropriate training – **do not** make connections to any pipe, cable or conductor.
- The equipment should not come in contact with corrosive or hazardous chemicals, or gases or dust.
- **Do not** directly connect this equipment to cables or pipes that have a potential difference to ground of greater than 25V AC.

Equipment Safety

- **Do not** open the enclosures (housings) of either the transmitter or receiver.
- Place the ground stake firmly in the ground before connecting the cable from the transmitter.
- **Do not** hold any uninsulated portion of the connection leads & clips when the transmitter is switched on.

Batteries and Environmental Safety

Vivax-Metrotech products use four types of batteries:

- Alkaline batteries
- Ni-MH (Nickel-Metal Hydride) batteries – rechargeable
- Lithium-Ion batteries – rechargeable
- Lithium-Metal batteries – (small non-rechargeable button cells for "clock" applications)

1. Alkaline Batteries (Non-Rechargeable)

- When replacing the alkaline batteries – use only the size and type specified – **do not** mix battery types (rechargeable and alkaline).
- **Do not** mix partially discharged and fully charged cells in the same battery pack – **do not** mix old with new.
- Never attempt to charge alkaline batteries.

2. Nickel-Metal Hydride Batteries (Rechargeable)

- When using rechargeable batteries, use only the correct charging device supplied or specified by the manufacturer. The battery pack or the battery charger will contain circuitry to manage the charging process – other chargers (even if they have the same connector, polarity, voltage & current rating will not have the same control circuitry and can cause damage to the product, overheating, and in extreme cases fire or harm to the individual.
- **Do not** assume that if the plug fits, it is the correct charger – a charger with the correct part number **must** be used – just because it is a Vivax-Metrotech charger, and the plug fits **does not** mean it is the correct charger.
- Before using for the first time, charge rechargeable batteries for six hours. If at any time the rechargeable batteries **do not** last as long as anticipated – discharge fully and then charge for six hours.
- Care should be taken when charging batteries – **Never** repeatedly recharge batteries (or turn power off & on) without using the instrument. If used with an inverter in a vehicle – charge the product then unplug the charger and **do not** charge again until the rechargeable batteries have been used for at least ten minutes. Failure to do this could result in the overcharging of the battery which will shorten the life of the battery and could in some circumstances cause overheating or fire.
- If ever the product becomes hot during the charging process, **immediately** unplug the charger and use the rechargeable batteries for at least ten minutes before recharging. If this reoccurs the next time the unit is charged – return immediately to Vivax-Metrotech for repair.
- **Do not** charge batteries for prolonged periods of time without using the locator for at least ten minutes. Charging for prolonged period of time could overcharge the battery, reduce the battery life and in extreme circumstances cause damage to the locator and fire.

3. Lithium-Ion Batteries (Rechargeable)

- Lithium-Ion Batteries – some products use Lithium-Ion batteries – the requirements for marking and transportation are still developing. Please contact Vivax-Metrotech before shipping products containing Lithium-Ion batteries or Lithium-Ion battery packs on their own for any "special instructions".

4. Lithium-Metal Batteries (Non-Rechargeable)

- Commonly known as "button cells" these are small – non-rechargeable batteries used to power internal "clocks" within some units (similar to computers). Generally, they have a life of three to five years.
- Under no circumstances should any attempt be made to charge these batteries.
- Dispose of to your company's work practice/environmental standards, the prevailing laws, or recognized best practice. Always dispose of batteries responsibly.

5. General Rules regarding Disposal of Batteries

- **Never** disassemble a battery, or battery pack.
- **Never** dispose of in a fire or water.
- Dispose of batteries in accordance with your company's work practice/environmental standards, the prevailing laws, or recognized best practice. Always dispose of batteries responsibly.

6. Transportation of Lithium-Ion and Lithium-Metal Batteries

- The Lithium-Ion and Lithium-Metal batteries used in Vivax-Metrotech products meet the required safety standards and include the designated protection circuitry.
- Recent regulation changes require that when batteries with Lithium-Ion and Lithium-Metal batteries are transported, the packaging **must** include specified warning labels.
- **Please contact Vivax-Metrotech Customer Service (USA 1-800-446-3392, International +1-408-734-1400 (USA Pacific Time Zone)) for more details.**
- Regulations have also changed regarding the shipping of spare battery packs (battery packs that are not inside a product). There are limitations on the weight of the package, and the packaging must be marked with the appropriate warning labels.
- **Please contact Vivax-Metrotech Customer Service (USA 1-800-446-3392, International +1-408-734-1400 (USA Pacific Time Zone)) for more details.**
- Vivax-Metrotech vLoc Series 3 products using Lithium-Ion battery are classified as "not restricted" they can be shipped normally by road/rail/sea & air (passenger & freight aircraft) without restrictions.



IMPORTANT

Remember – Batteries contain dangerous chemicals – They can be affected by many things such as water ingress or heat – In some circumstances they can explode. They also can cause electric shocks!

Care of Equipment

- Use equipment only as directed in this User Handbook.
- **Do not** immerse any part of this equipment in water.
- Store in a dry place.
- Keep equipment in the case provided when not in use.
- If left for prolonged period of time – remove alkaline batteries.
- Keep unit clean and free of dust and dirt.
- Protect against excessive heat.

Care when Interpreting the Information provided by the Locator

- Like all locators – this instrument is locating and providing depth and current readings based on electromagnetic signals that radiate from the buried cable or pipe. In most cases these signals will enable the locator to pinpoint both position depth and current correctly.
- **Beware** – in some cases other factors will distort electromagnetic fields radiating from cable or pipe being located, resulting in incorrect information.
- Always locate responsibly and use information learned during your training to interpret the information provided by the locator.
- **Do not** provide information regarding depth of cable or pipe to anyone unless authorized to do so by your company.
- **Remember** that depth measurements are to the center of the electromagnetic field or pipe – In the case of pipes this may be significantly deeper than the top of the pipe.

American & Canadian Safety Notices

USA

- This transmitter and receiver comply with the general conditions of operation, pursuant to part 15 of the FCC Rules.
 - o CFR 47 Part 2
 - o CFR 47 Part 15
- Changes or modifications not expressly approved by the manufacturer could void the user's authority to operate the products.

CANADA

- Equipment is for use by trained operators only, and not for general household or consumer use.
- Operation is subject to the following two conditions: (1) this device may not cause interference, and (2) this device must accept any interference that may cause undesired operation of the device.

EUROPE

- Vivax-Metrotech confirms that the location system is compliant with relevant provision of European directive 1999/5/EC.
 - o EN 55011
 - o EN 61000-4-2: A1 & A2
 - o EN 61000-4-3
 - o EN 61000-4-8: A1
 - o ETSI EN 300 330-2
 - o ETSI EN 301 489-1
 - o ETSI EN 301 489-3

Table of Content

- 1. Service & Support 1
 - 1.1 Serial Number and Software Revision Number 1
 - 1.2 Worldwide Sales Offices and Service Centers 2
- 2. vLoc3-Cam Receiver 3
 - 2.1 vLoc3-Cam Receiver Overview 3
 - 2.2 vLoc3-Cam Receiver Keypad 4
 - 2.3 Battery Packs 4
 - 2.4 User Menu 5
 - 2.5 Self-Test 6
 - 2.6 vLoc3-Cam Receiver Locate Screen Shots 7
- 3. Using the vLoc3-Cam 8
 - 3.1 Active Locating: Applying the Transmitter 8
 - 3.1.1 Direct Connection 8
 - 3.1.2 Signal Clamp (83.1kHz) 9
 - 3.1.3 Induction (83.1kHz) 11
 - 3.2 Locating Active Signals 12
 - 3.3 Searching (sweeping) an Area in the Peak Mode 12
 - 3.4 Tracing a Buried Line 13
 - 3.5 Depth Measurement 13
 - 3.6 Distorted Fields 13
 - 3.7 Sonde Location Mode 14
 - 3.8 Active Location of the Camera Rod 16
 - 3.9 Passive Locating 18
 - 3.9.1 Detecting Power Signals 18
 - 3.9.2 Detecting Radio Signals 19
 - 3.10 Depth Measurement in passive modes 19
- 4. Connecting to External Devices 20
 - 4.1 Bluetooth 20
 - 4.2 Pairing with external GPS/Dataloggers 20
- 5. MyLocator3 21
 - 5.1 MyLocator3 21
 - 5.2 My Locator3's Basic Operation 21
 - 5.2.1 Updates Page 21
 - 5.2.2 Application Update 22
 - 5.2.3 Locator Firmware update 22
 - 5.3 Toolbar 23
 - 5.4 Data Logging 23
 - 5.5 Splash Screen 23
 - 5.6 Frequencies Page 24
 - 5.7 Menu Settings 24
 - 5.8 Advanced Features 25
 - 5.8.1 Supervisor Lockouts 25
- 6. Accessories & Options 26
 - 6.1 Clamps 26
- 7. Glossary 27



1. Service & Support

1.1 Serial Number and Software Revision Number

Always quote your receiver and transmitter model number, serial number and software revision number when requesting product support. They can be found as follows: (for reference only).



1	Model & Serial Number
---	-----------------------



NOTE

Software Revision Number: The software revision number is displayed on the LCD during the startup sequence or can be found in the “About” section of the user menu.

1.2 Worldwide Sales Offices and Service Centers

Worldwide Sales Offices and Service Centers	
<p>World Headquarters, United States of America Vivax-Metrotech Corporation 3251 Olcott Street, Santa Clara, CA 95054, USA T/Free: 1-800-446-3392 Tel: +1-408-734-3880 Fax: +1-408-904-4964 Website: www.vivax-metrotech.com Email: SalesUSA@vxmt.com</p>	<p>Central/South America and the Caribbean Ventas para América Latina 3251 Olcott Street, Santa Clara, CA 95054, USA T/Free: 1-800-446-3392 Tel: +1-408-734-3880 Fax: +1-408-743-5597 Website: www.vivax-metrotech.com Email: LatinSales@vxmt.com</p>
<p>Canada Vivax Canada Inc. 41 Courtland Ave Unit 8, Vaughan, ON L4K 3T3, Canada Tel: +1-289-846-3010 Fax: +1-905-752-0214 Website: www.vivax-metrotech.ca Email: SalesCA@vxmt.com</p>	<p>France Vivax-Metrotech SAS Technoparc - 1 allée du Moulin Berger, 69130 Ecully, France Tel: +33(0)4 72 53 03 03 Fax: +33(0)4 72 53 03 13 Website: www.vivax-metrotech.fr Email: SalesFR@vxmt.com</p>
<p>Germany Metrotech Vertriebs GmbH Am steinernen Kreuz 10a, 96110 Schesslitz, Germany Tel: +49 9542 77227-42 Website: www.vivax-metrotech.de Email: SalesEU@vxmt.com</p>	<p>United Kingdom Vivax-Metrotech Ltd. Unit 1, B/C Polden Business Centre, Bristol Road, Bridgwater, Somerset, TA6 4WA, UK Tel: +44(0)1793 822679 Website: www.vivax-metrotech.co.uk Email: SalesUK@vxmt.com</p>
<p>China Vivax-Metrotech (Shanghai) Ltd. Building 10, Lane 1158 Zhongxin Rd., Songjiang District, Shanghai, China, 201615 Tel: +86-21-5109-9980 Website: www.vivax-metrotech.com Email: SalesCN@vxmt.com.cn</p>	

2. vLoc3-Cam Receiver

2.1 vLoc3-Cam Receiver Overview

The vLoc3-Cam is a Precision Sonde Location System designed to meet the needs of plumbers, plumbing contractors, utility companies and their contractors or anyone looking to locate sondes. The following describes the features and use of the receiver.

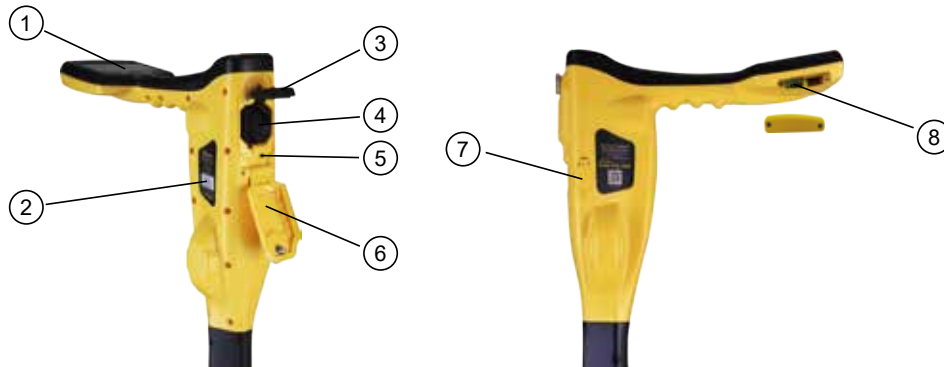
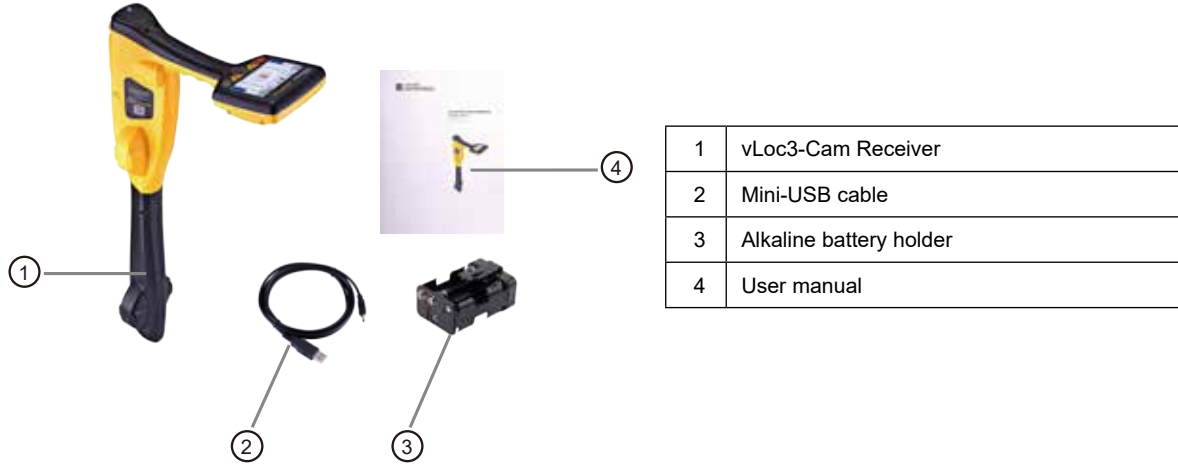

1	Pushbutton & Display	5	Mini-USB Port for Software Upgrade
2	Model number# & Serial number#	6	Battery compartment cover
3	Battery retaining cover	7	Charging port for optional rechargeable battery
4	AA Alkaline Battery Pack	8	Expansion sockets, not functional for the vLoc3-Cam

2.2 vLoc3-Cam Receiver Keypad

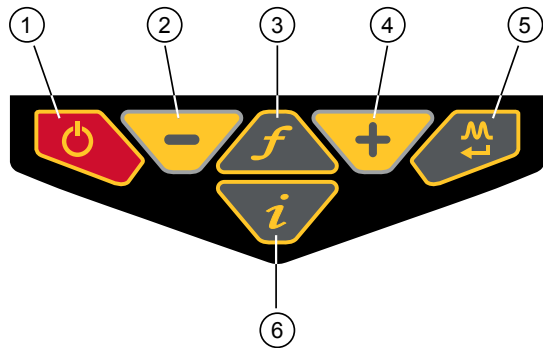

1	On/Off
2	Reduce sensitivity (Also scroll up when in User Menu)
3	Select frequency
4	Increase sensitivity (Also scroll down when in User Menu)
5	Short press = change antenna response Long press = change operational screen
6	Short press = enter information screen Long press = enter User Set-up options

2.3 Battery Packs

The vLoc3-Cam can be used with either alkaline batteries or an optional rechargeable battery pack.



The central illuminated section within the battery icon indicates the amount of charge remaining.

- Blue center indicates Alkaline batteries
- Green center indicates rechargeable batteries
- When batteries are low the charge remaining section becomes red and will flash

Just before shutdown the following symbol will be shown:



Alkaline battery replacement

- Unscrew the battery compartment cover and hinge downwards.
- Use the clip on the battery retaining cover to release the cover and hinge up.
- Slide out the battery holder and replace ALL 6 AA type batteries.
- Reverse process to replace the holder with new batteries.

Optional rechargeable Li-ion batteries

Rechargeable batteries are supplied with a mains charger. This is specific to the batteries, avoid the use of other manufacturers' chargers as these may damage the battery pack and may result in overheating of the battery pack.

To charge the rechargeable batteries, first make sure the pack is inserted in the receiver battery compartment as charging is done with the battery inside the receiver.



Connect the charger to the charging/accessory socket of the receiver. Connect the charger to the mains and switch on. The LED indicator on the charger will illuminate red until the batteries are fully charged at which time the LED will change to green.



WARNING

Rechargeable batteries are supplied with a mains or 12V DC charger. These are specific to the batteries. Only use the charger that is appropriate for the batteries in the product. If in doubt, call the Vivax-Metrotech customer service department at +1(800) 446-3392. Failure to use the appropriate charger could result in damage to the battery pack, locator and in extreme cases cause fire.

Avoid charging the unit in extreme temperature conditions. (i.e. below 0°C and above 45°C)

Although Vivax-Metrotech batteries include all the required safety related features, immediately discontinue use of the charger and battery pack if the battery pack becomes excessively warm. Return both to where they were purchased for investigation.

Always ensure batteries have at least a partial charge if storing for long periods without use.

Dispose of all batteries in accordance with your company procedures and Federal/State and local regulations.

Never dismantle batteries, put them in fire, or get wet.

2.4 User Menu

The vLoc3-Cam has several features that can be switched on and off. These features are accessed through the user menu.

Switch on the unit by pressing and holding the On/Off key until the start-up screen appears. The start-up screen can be configured to the user's preference and is described later in the manual. Otherwise the start-up screen will default to the one below:



Access to the User Menu is via the "i" button. Press and hold down the button until the menu appears.

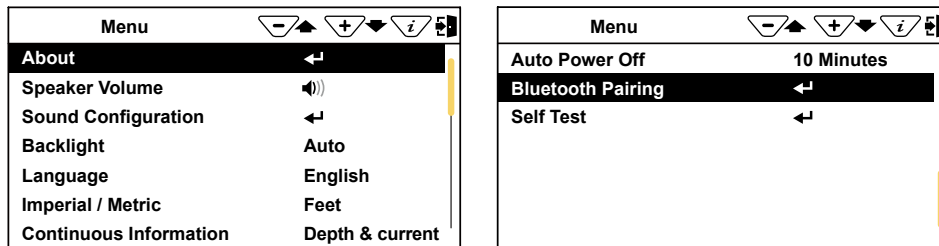

Main Menu

Note that the manual shows three screens but only one is shown on the vLoc3-Cam display at a time.

Note that where you see this sign it means that pressing the enter button gives access to the sub-menu associated with this button.

To exit the menu or sub-menu, press the "i" button.

Where the icon is not shown, the enter button is used to scroll through the options of that feature.

Use the "+" and "-" buttons to scroll up and down through the menu.

The features are described below:

About - This section holds the data about the locator such as software revision, calibration data etc.

Speaker Volume - Press the enter button to scroll through the speaker volume settings.

Sound Configuration - Allows configuration of sounds generated in locate modes.

- Active mode:
 - o Frequency Modulated (FM) Sound pitch changes with signal strength.
 - o Amplitude Modulated (AM) Sound volume changes with signal strength.
- Radio mode: FM or Real (Sound derived directly from received signal).
- Power mode: FM or Real.

Backlight - Press the enter button to change the backlight intensity setting. Note that high backlight setting will affect battery life. Or select "Auto" which automatically sets backlight depending on ambient light levels.

Language - The unit may be supplied with different language options. Use the enter key to select the language of choice.

Imperial/Metric - Select either Imperial or Metric measurements.

Continuous Information - The front Locate Screen can display a continuous reading of either Depth, Current, Both or can be switched off. Use the enter button to select your preference.

Auto Power Off - The unit can be set to switch off after a set time. Options are: 5-minutes, 10-minutes, or Never.

Bluetooth Pairing (Optional Feature) - Press the enter button to enter the Bluetooth pairing routine. This allows the unit to link with external devices such as dataloggers and GPS devices that have Bluetooth capability.

Self-Test - Pressing the enter key will initiate a series of self-tests. If any of the tests fail repeat the test in a more interference free site i.e. away from fluorescent lights, power signal sources etc. If the unit continues to fail, the unit should be returned to Vivax-Metrotech Corporation or one of its authorised service centers for repair.

2.5 Self-Test

The vLoc3-Cam has a Self-Test feature. The test confirms that the equipment is fit for use and calibration has not drifted from its expected settings.

To undertake the test, first find an area free from excessive interference such as overhead fluorescent lighting, large transformers etc. Also check that any nearby vLoc transmitters are switched off.

Select "Self-Test" from the user menu and press the "Return" button. The test will self-start. Keep the equipment stationary while the test is completed. After a short while the unit will report a Pass or Fail. Examples are below:



If the unit fails the test, try again in a more interference free area. If it continues to fail, return the unit to Vivax-Metrotech or one of its approved repair centers for investigation and repair.

2.6 vLoc3-Cam Receiver Locate Screen Shots

The user interface of the vLoc3-Cam is under continual development. The screen shots described may differ slightly from current screens.

The vLoc3-Cam gives the user a choice of two different locate screens. The choice of screen depends on the application.

- Classic Line/Pushrod Locate Screen
- Sonde Locate Screen

This manual will first explain the functions of the “Classic Line/Pushrod Locate Screen”.

An overview of the Classic Screen

Classic Screen:

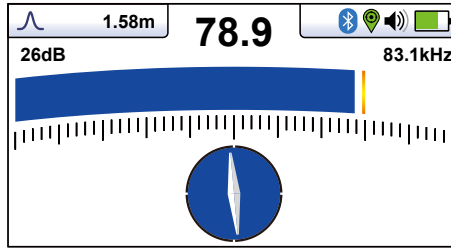

Status bar:

All the screens have a status bar at the top which indicates various settings of the locator. The bar is shown below:



1	Antenna configuration (meter response) described later in the manual
2	 This icon is shown in this position when the sonde locate screen is selected
3	Depth to target line or Sonde depending on locate screen selected.
4	Bluetooth status (Only if optional Blue tooth is installed)
5	Status of external GPS if paired with optional Bluetooth module.
6	Speaker volume setting
7	Battery type and remaining charge

The Classic Line/Pushrod Locate Screen has all the functions normally seen on a classic cable locator. The main functions being:

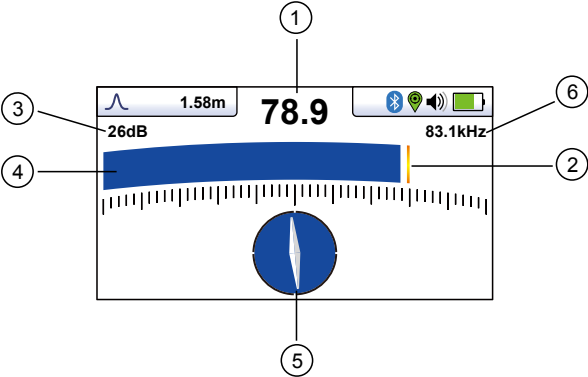
	1	Percentage signal strength (mirrors the bar graph setting)
	2	Peak level indicator
	3	Gain setting
	4	Bar graph signal strength indicator
	5	Compass line direction indicator (turns blue when aligned with target line)
	6	Frequency selection (flashing frequency indicates frequency selection is not valid for this screen. Choose another frequency)

3. Using the vLoc3-Cam

3.1 Active Locating: Applying the Transmitter

Active locating uses a transmitter to apply a precise frequency to a pipe or cable, then uses a receiver turned to detect the signal being radiated at that precise frequency. Active location frequencies can be applied by direct connection, signal clamp or induction. (This is further explained in the following sections) the active frequency used in the vLoc3-Cam is 83.1kHz).

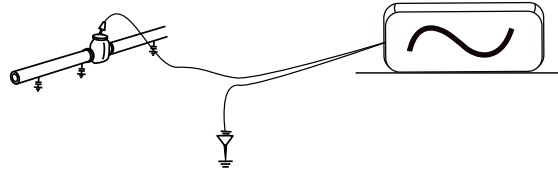

Active locating has the benefit that, unlike passive detecting, the operator is in control of the signals and therefore can be more specific about what line is detected. That is to say active signals can be used for line tracing. Also, passive signals are not always present on a line so using active signals ensures more lines are detected. (For passive locating see section 3.9)

To inject a signal requires the use of a transmitter. The signal can be injected, or applied, to the target line in a variety of ways.

3.1.1 Direct Connection

This method involves making an electrical connection to the cable or pipe.



WARNING

When connecting to a cable, only connect to the sheath of that cable. The direct connection leads are not designed for connection to live cables.



WARNING

Do not touch metal parts of the connection clips when connecting to the line or when the transmitter is on.

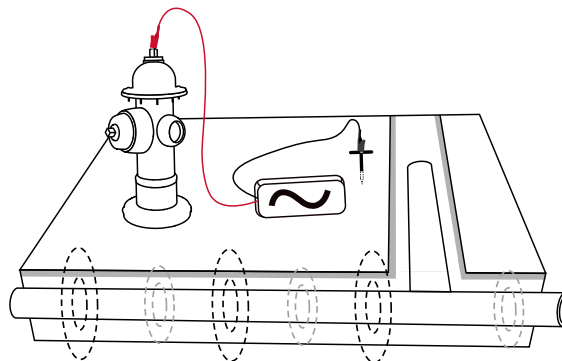

WARNING

Only authorized personnel should make connections to cables.

To make a direct connection, insert the direct connection connector to the transmitter. Insert the ground stake into the ground a few meters perpendicular to the line. Connect the black lead to the ground stake. Now take the red lead and connect to the target line.

3 Using the vLoc3-Cam

Switch on the transmitter by pressing and holding the on/off button down for a couple of seconds. Select the desired frequency depending on the application. Check for a good connection by either noting the mA output on the display or noting the change in tone rate when disconnecting and then reconnecting the red lead (depending on transmitter model).

Things that can affect the quality of the connection are:

1. Rusty pipe connection point: clean the connection area with a wire brush.
2. Poor grounding: try inserting the stake into damp ground. Dampen the surrounding ground with water. If still an issue, try connecting to a manhole cover surround. Avoid connecting to fence railings as these may create return signal currents along the fencing that will interfere with the locating signal.

Always start with a low output and increase the output if the received signal is not strong enough. Setting the output to high when it is not required may result in some of the signal “bleeding off” onto other services and will drain more power than necessary from the battery.

When connecting to a ferrous material, it is sometimes not possible to find a suitable projection to apply the connection clip. If this is the case, use the optional magnet to make contact to the line and then clip the red clip to the magnet. A good example of this is to make a connection to a street lighting circuit. Usually it is the practice to connect the sheath of a lighting cable to the metallic inspection cover of a street lamp. Making a connection to the inspection plate will energize the cable via the plate and sheath. Usually there is no projection on the plate on which to clip, so using the magnet on the plate provides a suitable clipping point.

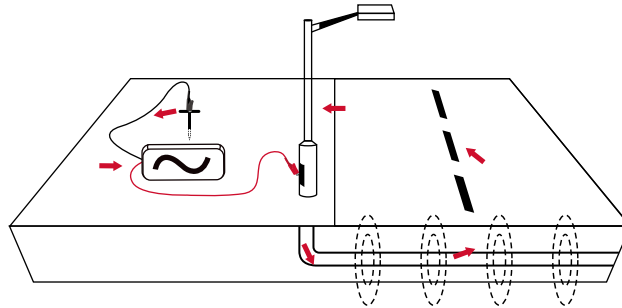

3.1.2 Signal Clamp (83.1kHz)

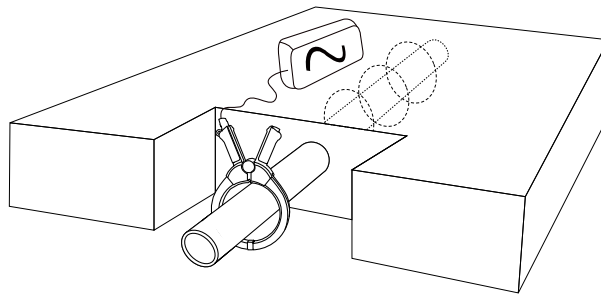

In many situations, it is not possible to gain access to a cable to make an electrical contact. Or if there is, it is not safe to do so. The signal clamp provides an efficient and safe method of applying a locate signal to a cable.

Note that for best results the cable should be grounded at both ends.

When clamping around a cable make sure the clamp is placed below the grounding point as shown below.

3 Using the vLoc3-Cam

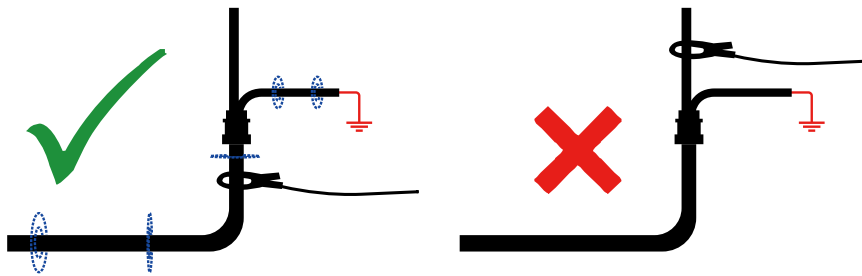

When applying a clamp close to a grounding point where multiple grounds or a grounding bus exists, ensure that you place the clamp around the target line and not to the ground bus/other grounds. This will help focus the applied signal to the target line.

Clamp Extension Rod

A useful accessory to the clamp is the extension rod:

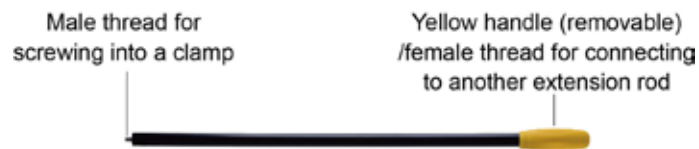

The extension rod is fitted with a 10mm threaded male stud. This male thread screws into the handle of the signal clamp to extend the distance of the clamp. This is helpful in areas with difficult access such as in manholes or overhead cables (not to be used on uninsulated overhead power cables).

The extension rod is also fitted with a female thread in the handle which enables the rods to be fitted together to further extend the range. To access this thread, slide the yellow handle off the rod.

To operate the clamp jaws when attached to the rod, gently pull on the clamp cord which will open the jaws. Release cable to close them.



WARNING

ALWAYS follow the appropriate safety requirements mandated by safety legislation, safety practice or your company's safety procedures when applying a clamp (coupler) to a cable.



BEWARE that when placing a clamp around cables carrying high current, the clamp may vibrate, jump or close violently due to inducted current from the target cable.

In some situations, high voltages can be induced back onto the clamp and be present at clamp's plug. Safety practices should be followed all times when clamping around live target lines!

In all situations ensure the clamp is connected to the transmitter before clamping around a line.

3.1.3 Induction (83.1kHz)

Note that Induction mode is not suitable for detecting camera rods.

With no direct connection lead or signal clamp connected, the transmitter will automatically start to radiate a signal around the transmitter. These signals will penetrate the ground and couple onto buried lines. The signal will then travel along the line which can be detected with the vLoc3-Cam locator.

Applying an induction signal to a line.

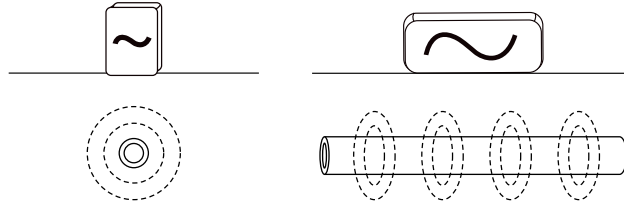

Remove any connections from the output connector. Switch on the transmitter and place it over the suspected position of the line and position it so that it is in line of the target as above. In the case of the Loc3-10Tx that is with the handle pointing along the line and in the case of other transmitters, arrows printed on the labels should point along the line of the target line.

The induction mode is particularly useful where there is no access to the line, but it should be noted that this is the least efficient method of applying a signal and it is also prone to signals being applied to adjacent lines.

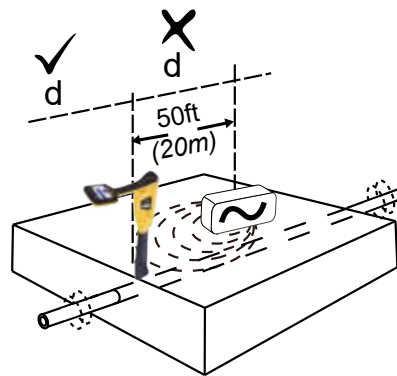

Also note that the signal will radiate out to the side of the transmitter as well as below. For this reason, it is recommended that when applying a signal using the induction method, a distance of at least 20m is kept from the transmitter when pinpointing or taking depth readings. Locating closer than 20m is possible but the operator should be aware that the signal directly received from the transmitter may be strong enough to influence the results.

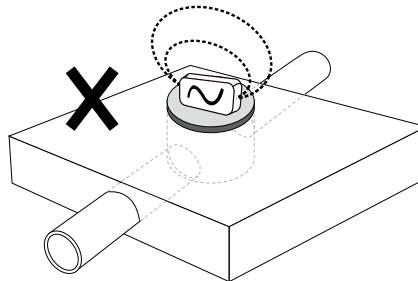

When using the induction mode, avoid placing the transmitter over metallic manhole covers as this will severely reduce the effectiveness of the transmitter and in extreme cases cause damage to the transmitter's circuitry.

3.2 Locating Active Signals

Apply an active signal to a line using one of the methods outlined above in section 3.1, active locating. Set the antenna configuration to "Peak".

Switch on the receiver and select a desired locate frequency matching the transmitter setting (83.1kHz).

Note that the screen will now show the addition of a compass (line direction indicator). In the presence of a locate signal the compass will align itself parallel to the line being located. This ensures that the operator is aware of the direction of the line.

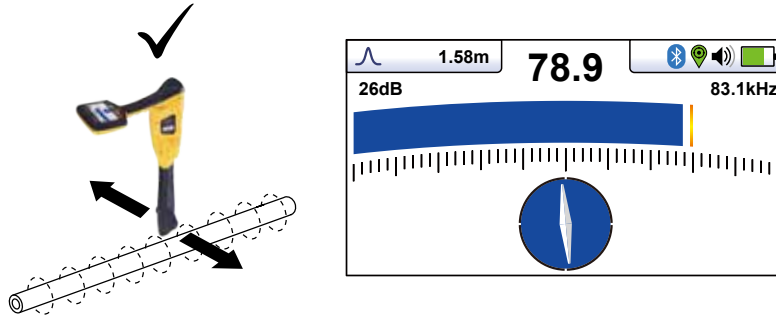

Hold the locator vertically and rotate it on its axis until the compass indicates Forward/Back as above.

Adjust the sensitivity control so that the display indicates approximately 50%. Keeping the vLoc3-Cam vertical, move to the side slightly. If the bar graph increases, you are moving toward the line. If it decreases, you are walking away from it. Move toward the line until a maximum signal is achieved. It may be necessary to reduce the sensitivity to keep the bar graph on scale. This is normal and should be expected. Try to keep the vLoc3-Cam vertical and avoid swinging it as this may create false readings.

Move the locator side to side to ensure a maximum signal is detected. Use the peak level indicator to assist.

With the maximum signal found and the compass running Forward/Back, the vLoc3-Cam is now directly over the line and exactly across it.

Continue to trace the line to its destination or source.

3.3 Searching (sweeping) an Area in the Peak Mode

In any given area, it is likely that buried pipes and cables are not parallel to each other, frequently they will cross the area being searched at a variety of different angles and depths. As the response of locator antennas is directional (using the traditional screen), it is important to search the area in the same or similar pattern as below. This orients the antennas in a way that will locate any signals being radiate from the buried line. Once a response is found, then trace and pinpoint the line and mark. Searching an area in this way is generally, (but not exclusively), done in the "Peak" mode using passive locating.

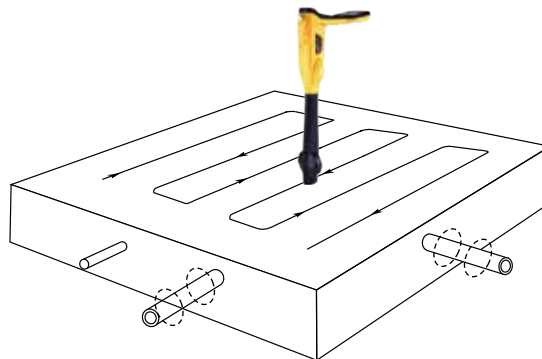

3.4 Tracing a Buried Line

Where possible trace out from the transmitter connection point. Having “pinpointed” the line, hold the locator vertically and in front of you with the compass line indicator pointing forward/back. Start by moving the locator left to right/right to left over the line. Keep the movement over the centre of the line ie the largest meter response, adjusting the gain when necessary. Whenever practical it should be traced to a point that provides additional confirmation of what type of service is being located i.e. a telephone pedestal, a manhole cover etc.

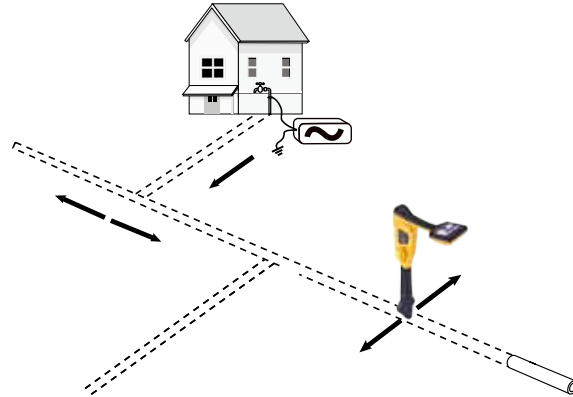

3.5 Depth Measurement

If the depth measurement feature is activated, it is possible to take depth measurement estimations. To take a depth measurement, first pinpoint the position of the line/rod as above. Place the tip of the vLoc3-Cam on the ground making sure it is vertical and across the line ie the compass indicating Forward/Back. Momentarily press the “i” button. The screen will change to a screen similar to the one below. In the case of locating a sonde or camera head, pinpoint the sonde as described later in the manual and press the “i” button to enter the information screen.

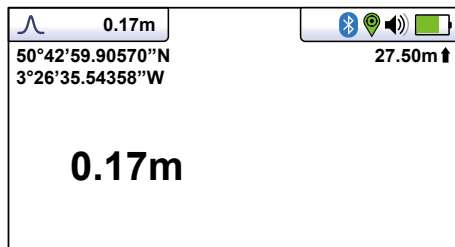

Line depth measurement screen

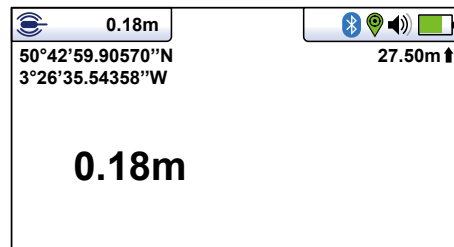

Sonde depth measurement screen

Depth readings are only available in the sonde and 83.1kHz line mode. Depth is not available in the Power and Radio modes.

The display shown above shows Longitude/Latitude positional information . To the top right is the height above sea level. This is only displayed when the equipment is paired with a valid external GPS system and a valid signal is received.

3.6 Distorted Fields

When locating, always be aware that you are locating the signals radiating from the buried line, these radiated fields, as they are called, can be distorted by other lines or electromagnetic signals from buried lines or metallic features like crash barriers or wire mesh fences. Also locating the camera rod close to the rod drum or close to the rod end may result in depth errors.

- Check to see if the signal is being distorted by other radiated fields. Locate the cable/rod/sonde. Take a depth measurement and not the reading. Lift the locator approximately 300mm or one foot and retake a reading. The depth should increase by the amount lifted off the ground. If it is different, treat the results with caution.
- Try not to take depth readings close to bends, “T”s, or where cables converge.

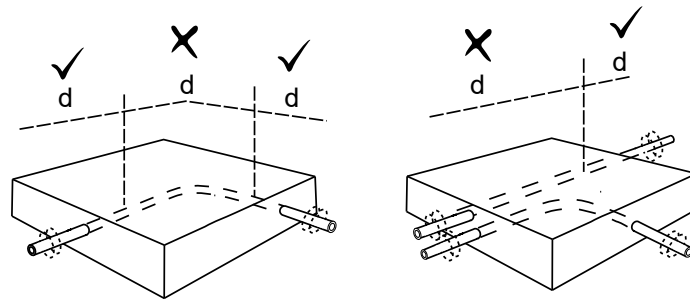

3.7 Sonde Location Mode

A Sonde is typically used for locating non-metallic pipes or ducts, and the camera end of a sewer inspection camera. Low frequency versions (512Hz/640Hz) can transmit through some metallic pipes such as cast iron pipes – which is why they are frequently used with sewer inspection cameras.

Sonde screen icons:

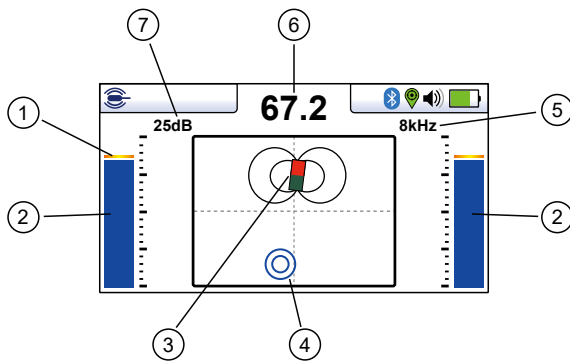

1	Peak signal detector
2	Signal strength bar graph
3	Sonde icon
4	Null point
5	Frequency selection
6	Numeric signal level (mirrors the bar graph)
7	Gain setting

A Sonde is a transmitting coil, the signal radiates in a different manner than that of a line.

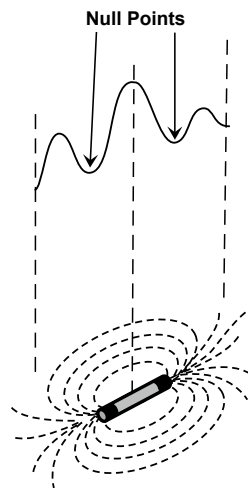

Due to this construction, the sonde gives a different “Peak” pattern note that there are three distinct peaks – a small peak – a large peak – a small peak with two “Nulls” between the peaks. The sonde is located under the center of the “large peak”.

The vLoc3-Cam detects the presence of the two “Null” signals and also the position of the main “Large Peak”. It uses this information to provide a reliable and efficient method of sonde location.

3 Using the vLoc3-Cam

Method:

1. Insert the activated sonde into the pipeline. In the case of an inspection camera, switch on the sonde using the appropriate controls on the control unit. Push the sonde/camera head about 10 – 12 Feet (3-4m) into the pipe.
2. Switch on the vLoc3-Cam and use long presses on the Return key until the sonde screen appears and the sonde icons appear at the top left of the display.



3. Press the " f " key to select the sonde frequency being used.
4. Hold the locator vertically and stationary with the tip on the ground.
5. If the locator is within the range of the sonde the screen will appear similar to the one below with an arrow pointing in a particular and steady direction. The bar graphs either side of the screen are identical and give an indication of the signal strength. Use the + and – keys to alter the receiver gain to keep the signal within the limits of the bar graph.

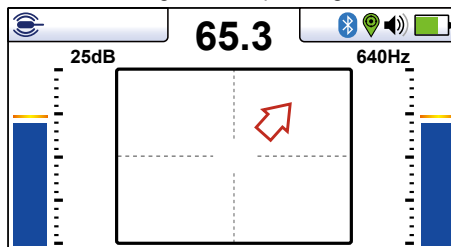

6. If the bar graph is not steady it will most likely be because the sonde is not within range. In this case hold the locator at approximately 45 degrees to the ground and rotate the locator around a full 360 degrees around you. Note the direction of strongest signal and walk towards it until the bar graph shows a steady signal. Now revert to step five above.
7. Walk slowly in the direction of the arrow.
8. A double circle will appear on the screen. This indicates the position of a null signal. Walk toward it and position it over the cross hairs of the screen. Now rotate the locator so that the arrow is pointing forward.

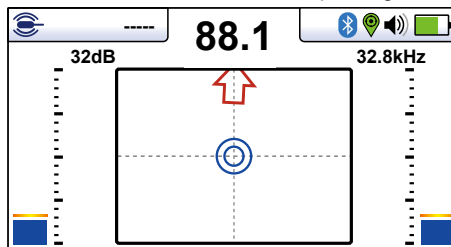

9. Keeping the null indicator on the vertical line, walk toward the arrow.
10. A Sonde icon will soon appear (Note that the arrow is not shown when the sonde appears). Keeping the locator vertical, carry on walking toward the Sonde until it is positioned on the cross hairs. The locator is now directly over the Sonde.

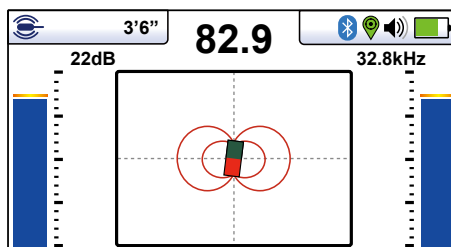

11. The diagram below provides an overview of the process:

3 Using the vLoc3-Cam

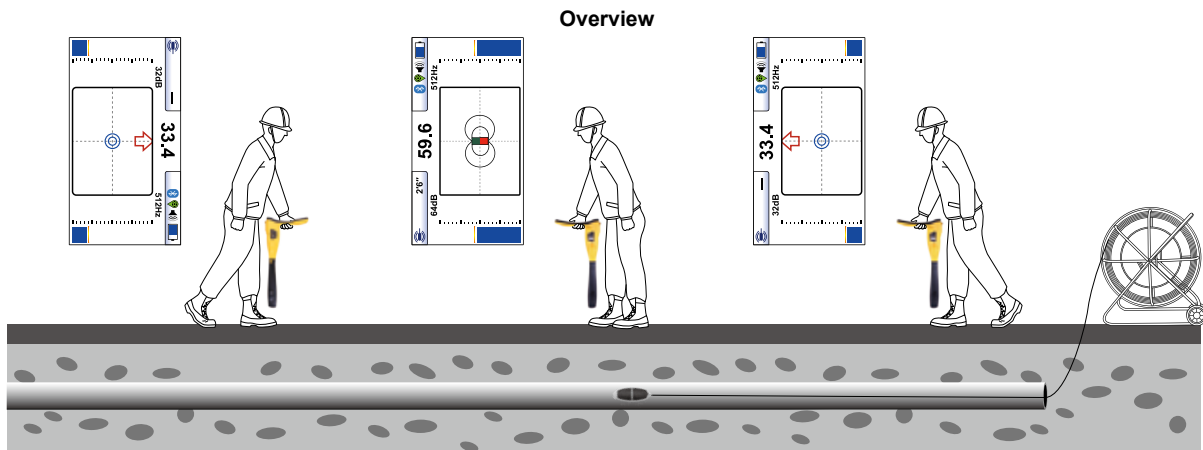

12. Note that when directly over the Sonde, it may be necessary to confirm the position of the Sonde, left to right. To do this move the locator left to right to identify the position of the strongest signal as indicated on the bar graph. At this time the depth to the Sonde will be displayed at the top of the display.
13. Having pinpointed the position of the Sonde, it can now be pushed in to a new location and the process repeated. It is advisable to keep the survey intervals to short distances such as six feet (two meters) as this makes the process of locating easier.

3.8 Active Location of the Camera Rod

It is sometimes necessary or desirable, to locate the route of the camera rod. This is made possible with the aid of a transmitter that applies a precise locate signal to one of the conductors within the rod. The signal is typically applied to a connection post. All later models of Vivax-Metrotech camera inspection systems have a connection post specifically for this purpose. The post is usually mounted near the hub of the drum. The picture below shows a typical location. The vCam-Tx has been specially configured for this task, providing 83.1kHz at 1 watt of power. However, any transmitter with a direct connection frequency of 83.1kHz is suitable for the task.



Pushrod Trace Post

Method:

- Applying a signal
 - o Connect the red lead of a suitable transmitter to the connection post.
 - o Connect the black lead to a suitable earth such as a ground stake inserted in the soil. Ground stakes are usually supplied with the transmitter.
 - o Make sure the leads are not going to impede the operation of the drum.
 - o Select 83.1kHz frequency on the transmitter.
 - o Insert the rod into the drain and push in approximately 5m (15ft) of rod. (less than this may not provide enough signal)

3 Using the vLoc3-Cam

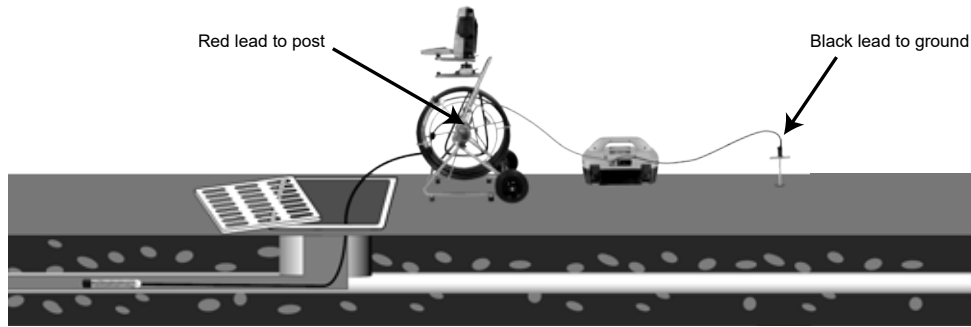

- Locating the Rod
 - o Apply the transmitter as above.
 - o Switch on the vLoc3-Cam and use the f button to select the frequency that matches the transmitter.
 - o Note that the screen will now show the addition of a compass (line direction indicator). In the presence of a locate signal the compass will align itself parallel to the rod being located. This ensures that the operator is aware of the direction of the rod.

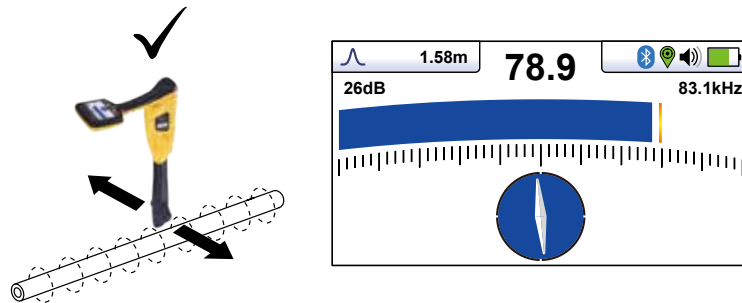

- o Hold the locator vertically and rotate it on its axis until the compass indicates Forward/Back as above.
- o Adjust the sensitivity control so that the display indicates approximately 50%. Keeping the vLoc3-Cam vertical, move to the side slightly. If the bar graph increases, you are moving toward the rod. If it decreases, you are walking away from it. Move toward the rod until a maximum signal is achieved. It may be necessary to reduce the sensitivity to keep the bar graph on scale. This is normal and should be expected. Try to keep the vLoc3-Cam vertical and avoid swinging it as this may create false readings.
- o Move the locator side to side to ensure a maximum signal is detected. Use the peak level indicator to assist.
- o With the maximum signal found and the compass running Forward/Back, the vLoc3-Cam is now directly over the rod and exactly across it. Note that the depth is also displayed in the box at the top left of the screen, unless a poor signal is detected.
- o Continue to trace the rod along the route.
- o As the end of the rod is reached the signal will rapidly reduce. This is to be expected.
- o If the exact position of the camera is required, switch the sonde on at the control box and use the vLoc3-Cam in the sonde mode to detect the camera head.

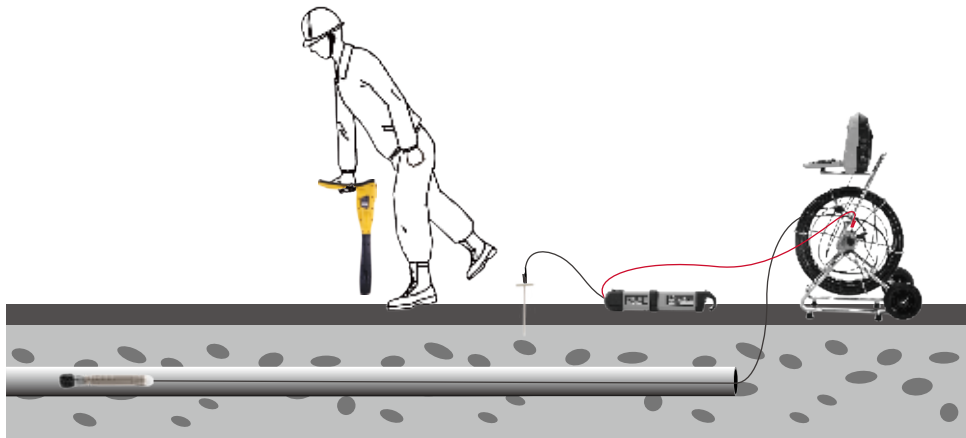

3.9 Passive Locating



NOTE
The compass indicator is not active during passive location.

Passive locating refers to the process of detecting signals that “naturally” occur on pipes and cables. These tend to fall into two categories, radio signals and power signals.

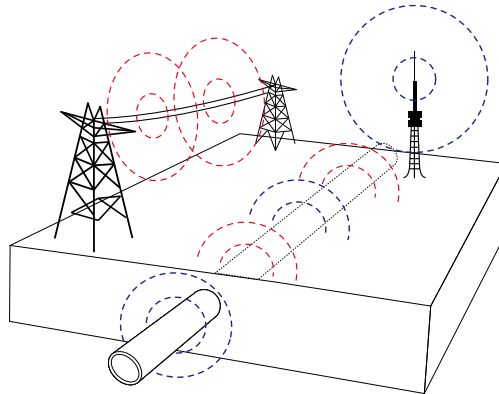

Radio signals are created by low frequency radio transmitters. These are used for broadcasting and communications. They are positioned throughout the world. As the frequencies are very low the signals tend to penetrate and hug the curvature of the earth. When the signals cross a long conductor such as a pipe or cable, the signals are re-radiated. It is these re-radiated signals that can be detected by the Radio mode.

Power signals are created by mains power running in the supply cables. These signals are 50 or 60Hz depending on country. For instance, the UK is 50Hz power but in the USA has 60Hz. When electrical power is distributed throughout the network, some of the power finds its way back to the power station via the ground. These stray currents can jump onto pipes and cables and also create power signals. Note that there has to be electrical current flowing to create a detectable signal. For instance, a live cable that is not in use may not radiate a detectable signal. Also, a very well balanced cable, ie exactly the same current flowing in live and neutral, will cancel out and may not create a signal. In practice this is unusual as there is usually enough imbalances in the cable to create a good detectable signal.

3.9.1 Detecting Power Signals

1. Switch on the vLoc3-Cam receiver and select Power mode using the “ f ” button. Notice that the antenna mode indicator will be showing “Peak” as this is the only antenna configuration available in the passive modes.

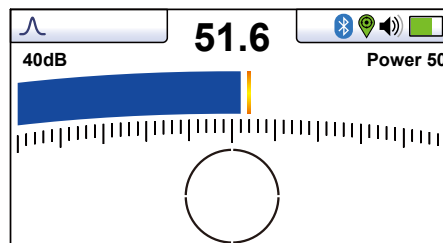

2. Hold the vLoc3-Cam vertically and away from likely positions of cables or pipes.
3. Adjust the sensitivity using the “ + ” and “ - ” buttons so that the bar graph reading is just starting to show some movement. Note that the compass feature is not available for the Power or Radio modes.



NOTE
Note that there will be no sound from the speaker until the meter reading is above approximately 10% of full scale.

3 Using the vLoc3-Cam

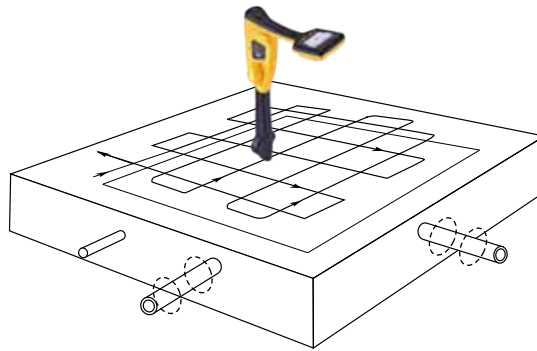

4. Keeping the vLoc3-Cam vertical, walk across the area to be checked keeping the orientation so that the display is pointing to the front. (See diagram above).
5. Continue in a grid across the area.
6. If at any time, the meter reading starts to increase, carefully move the locator side to side to detect the maximum signal. Use the peak level indicator to help confirm the correct position.

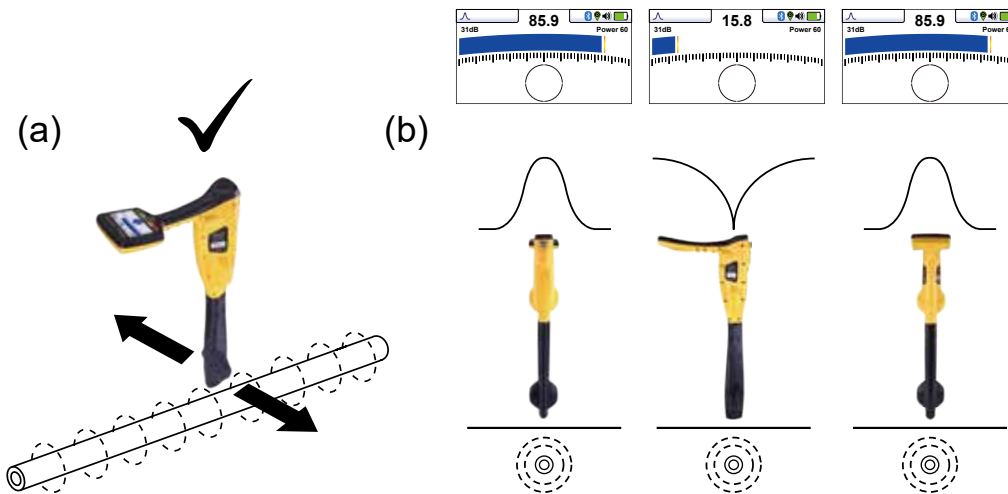

7. Rotate the vLoc3-Cam on its axis to obtain the maximum signal. The vLoc3-Cam is now directly over the line and with the blade across the line.
8. The direction can also be found by rotating until the smallest signal is detected. The blade is then in line with the cable/pipe.
9. Continue to locate the position of the line at regular intervals until its course is known through the target area.

3.9.2 Detecting Radio Signals

1. Locating radio signals is very similar to detecting power signals as they are both passive signals.
2. Hold the vLoc3-Cam vertically and away from likely positions of cables or pipes.
3. Adjust the sensitivity control so that the bar graph reading is just starting to show some movement. Now follow the procedure described above in the power mode section.

3.10 Depth Measurement in passive modes

Note that depth measurements are not available in the Power and Radio modes.

4. Connecting to External Devices

4.1 Bluetooth

As an optional extra the vLoc3-Cam receiver can be fitted with a Bluetooth communications accessory. This allows communication with external GPS and or Dataloggers. The Bluetooth option can be retrofitted and if required, should be included with the original order.

4.2 Pairing with external GPS/Dataloggers

To pair with an external device first ensure the Bluetooth option is fitted. This can be checked on the Status bar. If the Bluetooth icon is grey this means it is not fitted. Black icon indicates the option is fitted. The Bluetooth **cannot** be retrofitted to the vLoc3-Cam.

Method:

- Switch on the external device.
- Switch on the vLoc3-Cam and enter the User setup menu by a long press on the "i" button.
- Use the "+" and "-" keys to scroll down to the option "Bluetooth Pairing".
- Press the Enter key.
- Press the Enter key to commence "Bluetooth search".
- A list of available devices will be shown.
- Scroll down to the desired device and press the Enter key.
- Double press the "i" button to return to the main screen.
- After a few seconds the Bluetooth icon should turn blue indicating the device has paired successfully.
- The unit will remember the pairing even after switching off. However, the unit can only remember one unit at the time so if the unit is paired with another device the settings will be forgotten.

GPS (Global Positioning System)/GNSS (Global Navigation Satellite System)

The vLoc3-Cam can utilize location data from an external GPS/GNSS. For the vLoc3-Cam needs to be paired with an external device (see previous section on Bluetooth devices).

Once paired with an external device, the vLoc3-Cam will await valid GPS data from the external device. The GPS icon will turn green when a valid GPS signal is detected. This can take from a few seconds to a few minutes depending on the device and whether it is doing a "cold" or "hot" start.

Location data is displayed when in the "Information" screen.

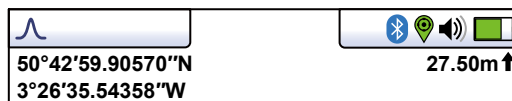

5. MyLocator3

5.1 MyLocator3



MyLocator3

This section describes the user operation of the MyLocator3 PC application.

MyLocator3 is a desktop PC application which is capable of downloading code and configuring the vLoc3-Cam series of locators.

The first part of this document (Basic Operation) describes usage not requiring a USB security dongle. The second part of this document (Advanced Features) describes usage requiring a security dongle.

MyLocator3 is a free downloadable App available at www.vivax-metrotech.com.

A “MyLocator3” icon will appear on the computer desktop.

Connect your vLoc3-Cam to your computer via the mini USB connector which can be found under the battery cover flap. Launch MyLocator3 by double clicking on the icon.

5.2 My Locator3's Basic Operation

MyLocator3 operation, not requiring a USB security dongle.

5.2.1 Updates Page

When a locator is first connected to the PC, the “**Updates Page**” will be displayed and this will show the locator variant type along with the locator serial number and the running firmware version in the upper left-hand box. The upper right-hand box will show information about the MyLocator3 PC application.

Clicking on the Clock symbol sets the locator time to UTC time. To check local and UTC time, hover over the icon and the times will be displayed to the right, flashing alternately.

MyLocator3 can also be viewed in a number of language options. Click on the pull-down menu to select the desired option.

Checking the “**Auto Load Config**” box ensures the configuration setting of the locator are automatically uploaded to the MyLocator3 app when the locator is connected.

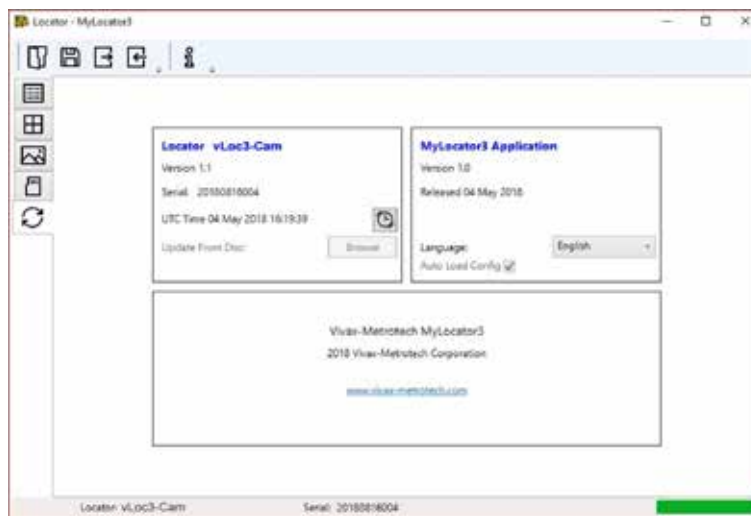

5.2.2 Application Update

Every time the MyLocator3 Application is started its version number is checked against the latest version available on the Vivax-Metrotech server and the user is notified if an update is available as shown below. This feature will only be available if the computer is “online”.

Clicking on the Update Now button will download the latest version from the Vivax-Metrotech server which can then be installed by the user.

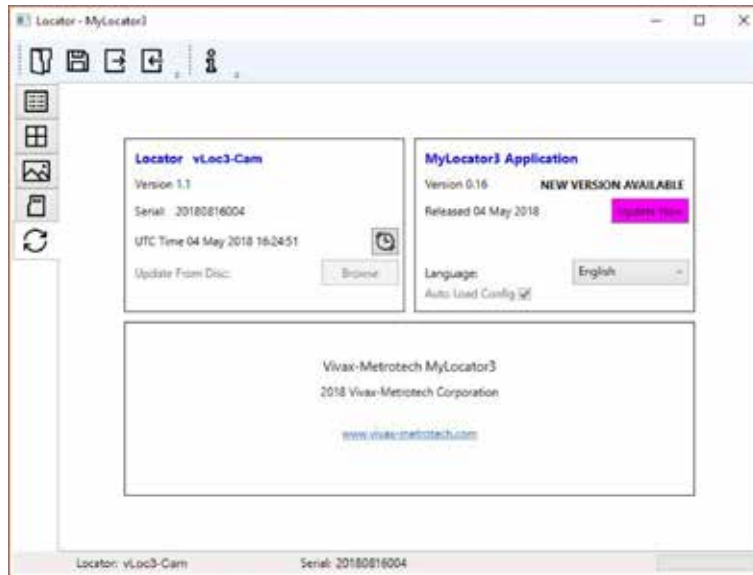

5.2.3 Locator Firmware update

Each time a locator is connected to the PC, it's firmware version is checked against the latest version available on the Vivax-Metrotech server and the user is notified if an update is available as shown below. This feature will only be available if the computer is “online”.

Clicking on the Update Now button will fetch the latest version from the server and then download it to the locator. The “Update From Disc” feature will only be available if a suitable dongle is also attached to the PC. This feature allows the user to install older versions of firmware stored on the computer, although it is advised that only the latest version of firmware is used.

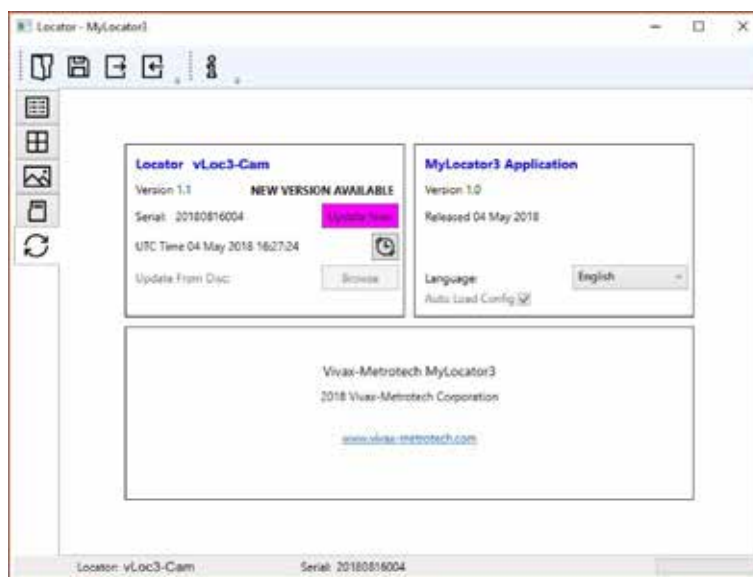





5.3 Toolbar

The vLoc3-Cam locator can be configured so that features can be switched on or off. This enables the user to tailor the instrument to meet the needs of their application while keeping the user interface uncluttered. The toolbar at the top of the screen enables the user to create configurations.

The application toolbar looks like this:



	This will open an existing configuration file (*.vmcfg).		This will read the configuration from the connected locator.
	This will save the configuration to a file.		This will display information about MyLocator3.
	This will write the configuration to the connected locator.		

5.4 Data Logging

The internal datalogging facility is not available on the vLoc3-Cam.

5.5 Splash Screen

On this page an image can be loaded which can be used as a splash screen by the locator when it is switched on. The locator has an LCD screen with a resolution of 480 by 272 pixels. The image loaded into MyLocator3 will be scaled to fit the width of the screen. If the scaled image height is less than the LCD height, then the image is centered vertically and white bars are used as padding. If the scaled image height is greater than the LCD height, then the image can be re-positioned vertically by clicking and dragging the left mouse button anywhere on the image.

To insert your own start up screen first click on the "Open" button. Then browse your files to select the picture required as the startup screen. The application is compatible with file formats .jpg/.bmp/.png, and .gif.

The startup screen will be displayed in the application.

The Download button can be used to set the splash screen immediately or the image can be sent to the locator along with the rest of the configuration by pressing the Write Configuration button.

To remove a start-up screen and revert to the default Vivax-Metrotech screen click on the "Clear" button and download the cleared screen.



5.6 Frequencies Page

The "Frequencies" page will allow the user to refine which frequency modes are available when the locator F-key is pressed and which frequencies appear on the locator menu.

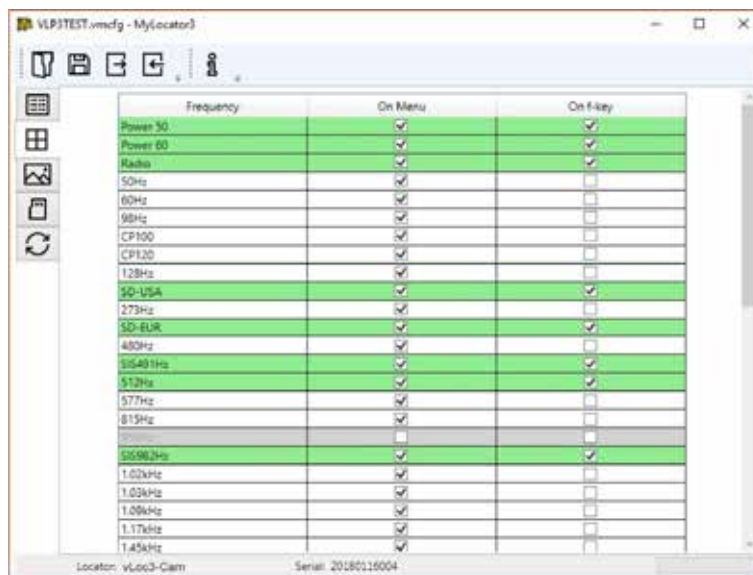

5.7 Menu Settings

The "Menu Settings" page allows the user control over which menu items appear on the locator and also the initial setting of the menu item when the locator is first used after configuration.

The menu items with a right pointing arrow  can be expanded to reveal further sub-menu items. If the "On-Menu" item is ticked, then the item will appear on the locator menu. The item displayed in the "Setting" column will be the initial locator setting after configuration. If the "Setting" value is not selected, then the locator setting will be unchanged.

5.8 Advanced Features

The Advanced Features are available to those users in possession of a USB security dongle. If a dongle is attached to the PC then its level will be displayed on the MyLocator3 status bar.

5.8.1 Supervisor Lockouts

This feature is available to anyone with a dongle (contact Vivax-Metrotech for the purchase of a dongle). When a dongle is connected to your computer via a standard USB socket, the icons for the "Splash Screen" page, "Frequencies" page and "Menu Settings" page will change color to green. This color indicates the page is unlocked.

The Splash Screen page, Frequencies page and Menu Settings page can each be individually locked by double-clicking on their page tab icon. If a page is locked then it can only be accessed by a user with an appropriate security dongle. This will prevent unauthorized users from changing protected locator items. i.e. the "Splash Screen" can be locked to prevent the user from changing it.

The page tab icon will change color from green to amber.

To unlock a tab, with the dongle connected, double click on the tab to unlock.



6. Accessories & Options

6.1 Clamps





An accessory used to apply the transmitter signal to an insulated line, removing the need to connect the transmitter signal directly to a conductor or cable sheath.

- Available in 4-inch (100mm) and 5-inch sizes
- An 18-inch (45cm) flexible version is also available

Visit us at www.vxmt.com to see the full range of receiver and transmitter accessories and available options.

7. Glossary

Active Locate	A locate where a transmitter is used to apply a signal to a buried pipe or cable, the position of which is then located by a receiver tuned to the same frequency.
Active Signal	A signal applied by the locator transmitter to a buried line. Typical this is a very precise frequency.
Attenuation	The reduction of an electromagnetic signal from a pipe or cable.
Clamp (or Coupler)	An accessory used to apply the transmitter signal to an insulated line, removing the need to connect the transmitter signal directly to a conductor or cable sheath.
Compass	Line direction indicator (although visually like a compass, this is the only relation to a compass).
Coupling	The act of signals transferring to lines to which they were not originally applied. Coupling can be "direct" where the target line has an electrical connection to another line, or "induced" where the signal radiates from the target line to another line or lines.
Display	The information visually available on the dot matrix display.
Line	A generic term for any buried pipe or cable.
Null	A minimum response to a buried line. 
Passive Locate	A locate where the receiver searches for a wide range of signals that radiate from buried pipes or cables. These signals come from a variety of sources in the environment and couple to the buried (& overhead) lines. Typical examples 50/60 Hz and LF/VLF radio.
Passive signals	A wide range of signals that radiate from buried pipes or cables. These signals come from a variety of sources in the environment and couple to the buried (& overhead) lines. Typical examples 50/60 Hz and LF/VLF radio.
Peak	A maximum response to a buried line. 
Pinpoint	Using a receiver to identify the exact position of a buried line
Response	The indication that the receiver gives which is caused by the signals it is receiving. This can be visual, audio or both. Typically, it is displayed on the locators dot matrix display and audibly from a loudspeaker in the receiver housing.
Search (sweep)	This describes the act of looking for a buried line within a given area.
Sonde	A small transmitting coil which may be built into a product such as a sewer camera or packaged as a small self contained battery powered transmitter. A receiver tuned to the same frequency can locate the position of the Sonde and hence whatever it is attached to or in. Frequently used for locating sewer cameras, and the non metallic pipes.
Target Line	The buried pipe or cable to be located.
Trace	Using a locator to following the path of a buried line.

Illustrations used in the preparation of this manual will inevitably show some resemblance to similar illustrations from other manufacturers. Some manufacturers have given permission for the use of their graphics is given credit for these use. This statement is intended to attribute such credit.

Disclaimer: Product and accessory specification and availability information are subject to change without prior notice.

