

This section of the manual covers the 25-Watt Loc3-25Tx transmitter.

1. Loc3-25Tx Transmitter Overview

The Loc3 series transmitters are rugged portable transmitters powered by Li-ion rechargeable batteries or alkaline "D" cells.

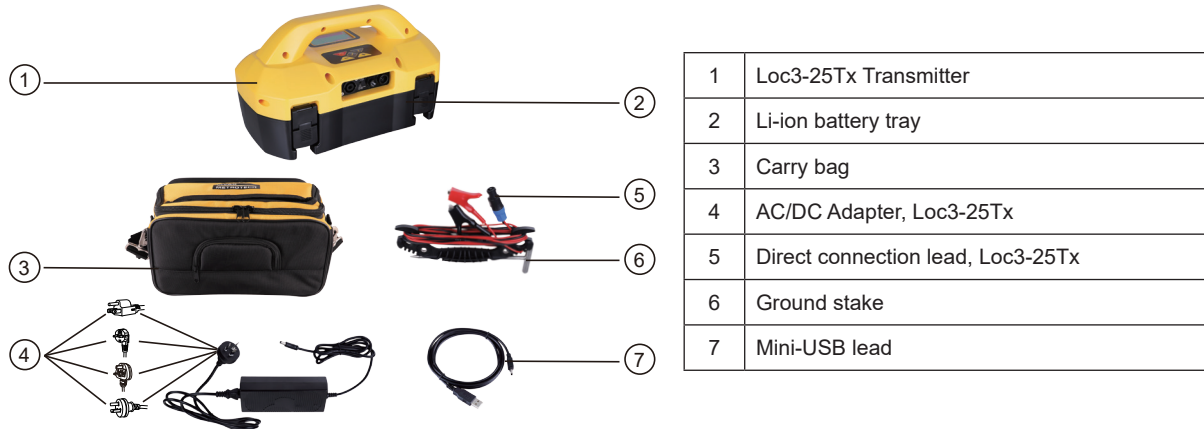

1.1 Display

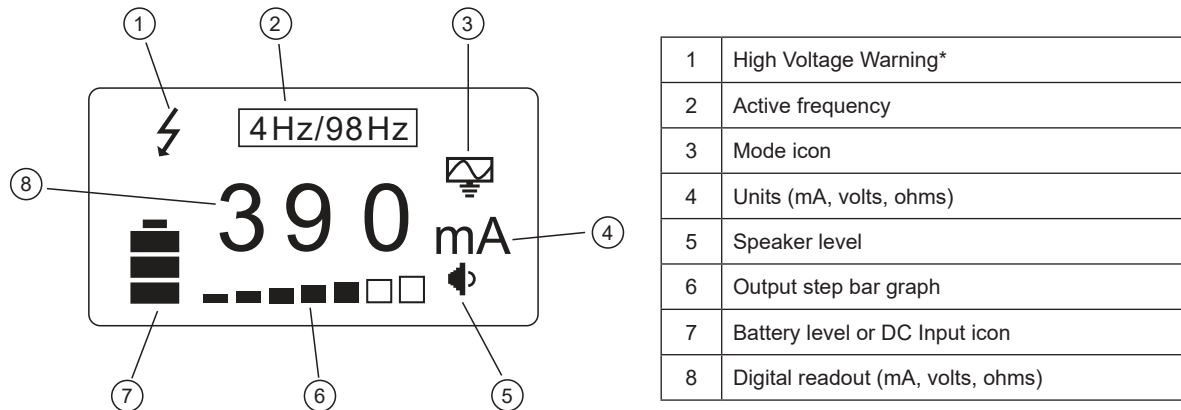

*Output Protect Warning

The transmitter checks the line when connected. Output protected against accidental momentary connection to up to 230V AC (RMS), it will display the "high voltage" warning icon and not allow the transmitter to operate. In addition, the transmitter is protected by a 4A/250V fuse in the event of excessive voltage or voltage spikes on the line.

1.2 Pushbuttons

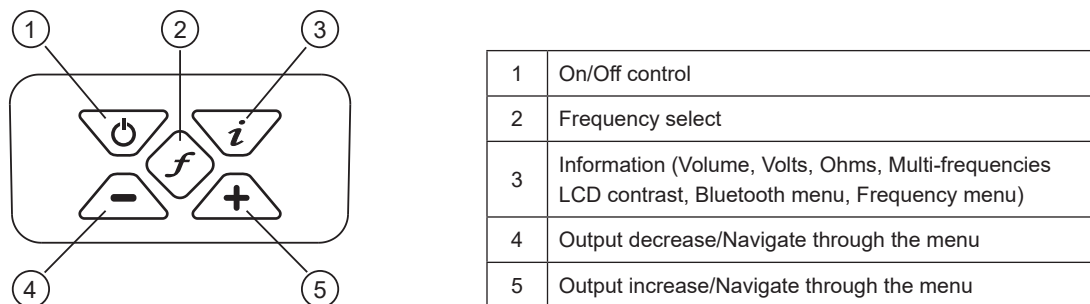

1.2.1 Information Pushbutton

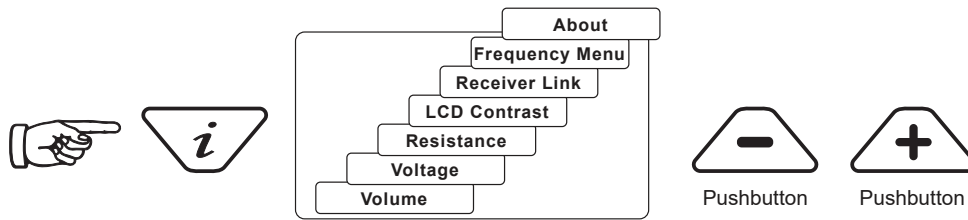

When the “i” (information) pushbutton is pressed, the display will show the volume level of the audio; use the “+” and “-” pushbuttons to increase/reduce the volume or turn the beeper off (off-low-medium-high).

Keep pressing the “i” (information) pushbutton, and the display can be toggled to show “voltage,” “resistance,” or other functions, as shown in the drawing above. The display indicates mA as the default and volts or ohms when selected.



NOTE:
The number of “i” button presses and available sub-menus will vary with the transmitter’s mode.

1.2.2 Connections Block

25-Watt Connection Block

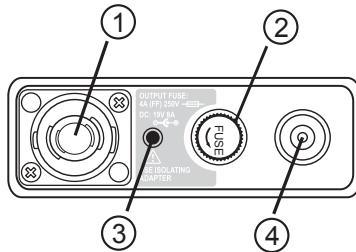

1	Output connection, speakON® socket
2	Output protection (4A/250V Fuse)
3	Loudspeaker
4	Battery charging socket & DC input

All locating connections are made via the connection block. Firmware updates are made via a USB socket mounted inside the battery compartment.

The connection block consists of:

- Output (speakON®) socket (25-Watt transmitter) – for the direct connection lead.
- Charger socket (to charge rechargeable battery pack).
- Transmitter 19V DC power lead is used to power the transmitter from AC/DC power supply.
- Fuse, 4A/250V – this protects the transmitter circuitry in the event of the transmitter receiving up to 250V incoming voltage on the output leads, or higher than the allowed current.
- A beeper is positioned behind the small hole.

2. Transmitter Batteries – Li-ion and Alkaline

The 25-watt transmitter ships with a custom Li-ion battery tray with a charger and power cable.

The battery status is shown on the transmitter’s LCD. The letters “LP” will appear when the battery status reaches only one bar. At this battery level, the max output current and power are limited.

The LED on the charger will show a red light indicating that the charge cycle is in progress. When the batteries are fully charged, the LED will change to green.

Follow instructions detailed in the General Safety & Care Information section of this document. Dispose of batteries following your company’s practice and environmental standards, the prevailing laws, or recognized best practice. Always dispose of batteries responsibly.



NOTE

The 25-watt transmitter ships with the Li-ion battery tray as a standard part. Alkaline can be used with the 25-watt transmitter, but the power output will be limited to 10-watts.



WARNING

Use only Vivax-Metrotech recommended charger.

Do not attempt to replace the rechargeable batteries or remove battery covers.

Return to Vivax-Metrotech or a Vivax-Metrotech approved service center for replacement.

2.1 Charging the Transmitter Battery Tray

The rechargeable battery tray can be charged while attached to the transmitter or on its own.

1. Connect the charger to the charging socket on the transmitter's side or directly into the battery tray's charging socket.
2. The LED on the charger will glow red while charging and turn green when fully charged.



Plug the charger into the charging socket on the side of the transmitter or directly into the battery tray.



NOTE

The rechargeable tray cannot be charged from a 12V DC source.



WARNING

Only use a charger supplied by Vivax-Metrotech Corp. Using non-approved chargers may result in damage to the equipment or overheating/explosion.

The battery condition (charge) is displayed on the left side of the display.

Follow instructions detailed in the General Safety & Care Information section of this manual. Only use the battery charger supplied as using an unapproved charger may damage the battery pack and may cause overheating.

2.2 Removing and Installing the Battery Tray

Removing the battery tray

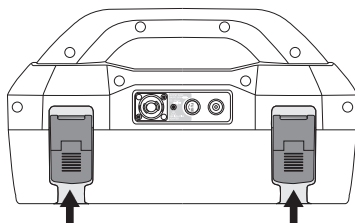

1. Pull out the bottom of the catch
2. Lift the transmitter from the battery tray

Installing the battery tray

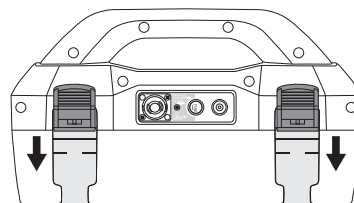

1. Lower the transmitter into the tray
2. Push up button underneath the catch while holding it up.
3. Push in the bottom of the catch until you hear a positive "click."

3. Transmitter Mode



WARNING

Always connect the transmitter to a target line following all the company procedures. This operation should only be performed by authorized personnel. Always make connections before switching on the unit. Switch off before disconnecting the transmitter.



NOTE

When the transmitter is powered on without connection leads, a “NO CONNECTION” message will appear. Power off the transmitter and insert the connection leads, and proceed with power up.

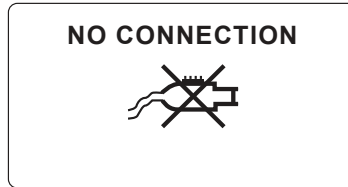

3.1 Direct Connection Mode

The **Direct Connection** mode is automatically selected by plugging a connection lead into the output socket. An icon confirming the direct connection mode is shown on the display. The wave in the icon fluctuates when the transmitter is operating. The direct connection lead consists of two colored cables with clips and covers. The red clip must be connected to the conductor being located, the black clip to a suitable ground such as the ground stake provided with the transmitter.

A good connection is indicated by a change in the beep rate from the speaker and the current reading on the display.

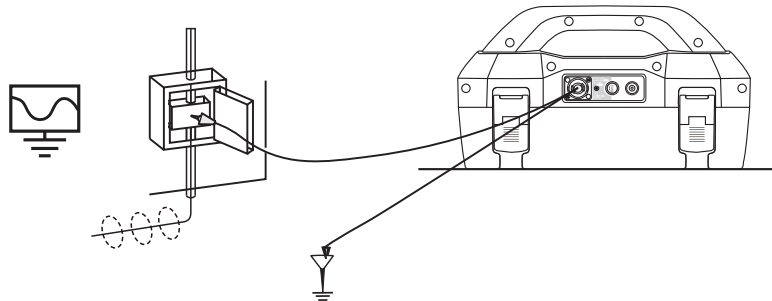

Wherever a direct connection can be safely made without the risk of injury, damage to the customer’s plant, or the transmitter, it is the best way of applying the transmitter’s signal.

The positioning of the ground connection can also influence the degree of coupling experienced. Ground connections generally should not be made to other pipes or cables or above ground metallic structures such as wire fences. In general, the lower the frequency is, the further the signal will travel, and the less signal-coupling will occur. The most common frequencies used for direct connection are between 512 Hz/640 Hz and 8 kHz.

Regulations in many countries require that power output is limited above specific frequencies. The Loc3 series 5-watt, 10-watt, and 25-watt transmitters enable frequencies below 45 kHz to be transmitted using as much as 5-watts, 10-watts or 25-watt output, depending on your transmitter, but frequencies over 45 kHz are restricted to 1-watt. Using direct connection and the higher power at the low frequencies helps significantly in achieving greater location distances. Direct connections should not be made to cables carrying greater than 25V (or as your safety practices allow). The transmitter is protected (250V fuse) from stray currents that may exist on the target line.

3.2 Clamp Mode

The transmitter signal clamp is a precise way to apply the locate signal. Clamps are generally used when it is impossible to access the conductor to make a direct connection, but there is access to place the clamp around the cable. Clamps are also used when it is not safe to connect because the target cable is live carrying electricity.

The clamp is a specialized inductive device (sometimes known as a toroid or coupler). All clamps are optimized to work at specific frequencies. In most cases, clamps are designed to be used at frequencies generally between 8 kHz and 9.82 kHz. The transmitter will only allow the selection of a suitable range of frequencies for your clamp.

Plugging a Vivax-Metrotech clamp into the output socket will place the transmitter into the “Clamp” mode. An icon confirming this is shown on the display and will flash when the transmitter is transmitting.

When using the clamp, no ground connection is needed.

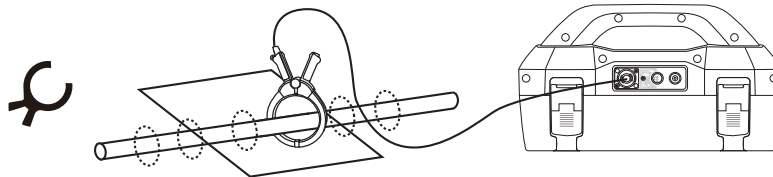

WARNING

When applying the clamp to cables that carry electricity – be sure to follow your company’s safety instructions and procedures. Beware that if applied around a high voltage cable – that cable may induce a current in the clamp, causing it to snap shut or jump quite dramatically – always apply clamps carefully.

4. Transmitter Frequencies

The Loc3-25Tx transmitters are supplied with a predefined set of transmitting frequencies. The factory will preset the most commonly used frequencies. Additional frequencies are available to be selected in the frequencies list; see section 4.2.

4.1 Frequencies and Maximum Power Output

Frequencies power outputs	Loc3-25Tx
Direct connection 25-watt:	32Hz-9.82kHz

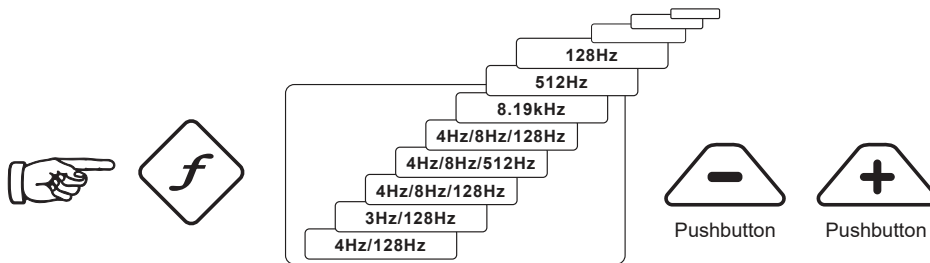

As with most manufacturers, signal clamps are tuned to specific frequencies and **will not** work over the complete range of frequencies.

Frequencies are selected by pressing the “f” pushbutton, which toggles through the frequencies available in the current mode’s available frequencies. The frequency is automatically selected if you don’t toggle past it within two seconds.



NOTE

The output current is shown in large characters on the display. To increase or reduce the current output, press “+” or “-.” The vertical bar graph at the bottom of the display indicates which of the seven current output steps is being used. If the transmitter can supply the requested current, the bar will turn black. If the bar does not turn black, improving the ground connections or wetting the ground where the earth stake is positioned may help. However, it may not achieve the current setting requested because the line's impedance is too high for this setting. If this happens, it is best to select a lower setting with a black bar, ensuring a stable output.

The impedance of the target line will limit the current being transmitted; therefore, it is not unusual to increase the output level but see no increase in the currently displayed. This is not a fault with the transmitter.

The transmitter will always revert to first level output when switched on as a power-saving feature. In most circumstances, this output level is sufficient. Increasing the output power unnecessarily will reduce battery life. All other settings remain the same as the last setting used.

4.2 Most Used Frequencies (Frequency Selection) Feature

This feature allows the operator to choose the most used frequencies from a list of frequencies. Once these frequencies are selected in the main menu, the user can scroll through them by pressing the “f” pushbutton. The user can add or remove frequencies from the above list by following the below procedure. The maximum number of frequencies that can be activated in the most used frequencies list is 12.

The advantage of this feature is the user can work with only their preferred frequencies rather than having a more extensive list of frequencies to scroll through.

Enter the Frequency Menu:

1. Press the “i” pushbutton four to six times (based on the mode that the transmitter is in) until reaching the “Frequency menu” sub-menu.

In Direct Connection mode

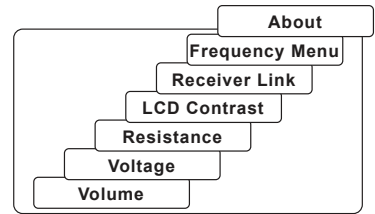

In SD mode

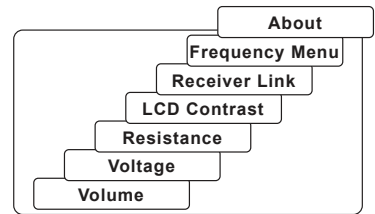

2. The screen will show a list of frequencies available, with the central one in a box.

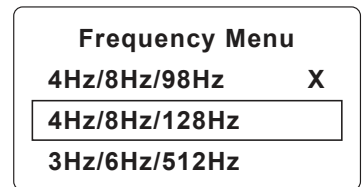

3. Pressing the “+” or “-” pushbuttons, you can scroll up or down through the available frequencies.

The Loc3-25Tx Transmitter Insert

www.vivax-metrotech.com

4. Once the wanted frequency is inside the box, press the “f” pushbutton to select or deselect the frequency. An “x” will appear in the box for a selected frequency.

Frequency Menu	
4Hz/8Hz/98Hz	X
4Hz/8Hz/128Hz	X
3Hz/6Hz/512Hz	

5. After selecting the frequencies, press the “i” pushbutton again to exit the “Frequency Menu” and return to the main display.
6. A particular frequency in the chosen list of frequencies can be selected from the screen by pressing the “f” pushbutton until the wanted frequency is displayed at the top of the main screen.

Vivax-Metrotech Corp. (Headquarters)

3251 Olcott Street, Santa Clara, CA 95054, USA

T/Free: 1-800-446-3392

Tel: +1-408-734-3880

Fax: +1-408-734-1415

Email: SalesUSA@vxmt.com

Website: www.vivax-metrotech.com

Visit us at www.vivax-metrotech.com to view our full product line and worldwide locations.



